

KICHLER®



INDOOR LIGHTING
SYSTEMS



Add Beauty to Every Detail

Bring architectural features out of the shadows with Kichler® Lighting Systems.

Task lighting. Accent lighting. Mood lighting. Incorporate alluring lighting effects just about anywhere. With a Kichler Indoor Lighting System, your project is a blank canvas. Our lighting solutions are the tools of your design: highlight architectural details; see counterspace more clearly; light up a closet or cove; navigate at night seamlessly. Anything is possible.



Table of Contents

Every nook and task that requires illumination has a Kichler® solution.

Under Cabinet Lighting

- 6 6U Series LED
- 7 4U Series LED
- 8 Fluorescent
- 9 Accessories

LED Tape & Accent Lighting

- 12 How to Build a System
- 14 8T Series 24V LED Tape
- 16 6T Series 24V LED Tape
- 19 4T Series 12V LED Tape
- 20 6D Series 24V LED Accent Discs
- 20 4D Series 12V LED Accent Discs
- 21 Hard Strips 24V LED
- 22 LED Driver + Dimmer
- 23 Power Supplies & Accessories

Extruded Channels for Tape Light

- 30 Pro Series
- 50 Enhanced Series
- 58 Standard Series
- 64 Channel Depth & Lenses
- 66 Accessories
- 67 Tracks & End Caps

LED Step & Hall Lighting

- 70 Step & Hall 120V LED

Technical Resources

- 74 Power Supply Optimization
- 76 Advanced Product Solutions & Layout
- 77 Symbols & Abbreviations
- 78 Index





Under Cabinet Lighting

Easy-to-install countertop illumination.

Versatility and beautiful illumination all in one: Kichler® under cabinet fixtures include integrated drivers for easy hardwire capability to get the job done quickly, with minimal components or accessories. Our most popular options feature long-lasting, efficient LED technology: choose from our 6U Series for 2700K or 3000K color selection in one; or our 4U Series for gently diffused light delivery.



6U Series LED

Two-in-one selectable color temperature to customize any installation.

Take the guesswork out of choosing the right lighting: the 6U Series LED from Kichler Lighting allows you to choose a warm or pure white light with the flip of a switch. You get variety and customization that can change easily to enhance your decor in different ways throughout the day. It's a beautiful end effect that always works with whatever countertop, paint or cabinet colors you have in your workspace.

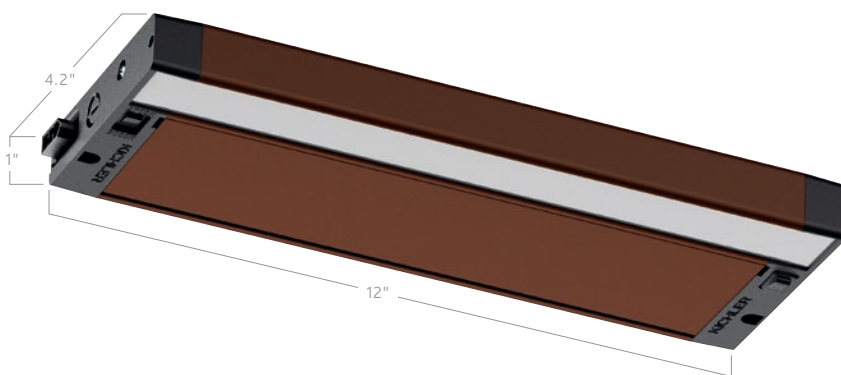

Shown: 6UCSK12BZT

Finish, Color Temperature and Size

Available Finishes	Finish, Color Temperature and Size		Available Finishes
Available Finishes	Textured Bronze (BZT), Textured Nickel (NIT), Textured White (WHT)		
Color Temperature	2700K - Warm White and 3000K - Pure White		
Size	8"	6UCSK08 BZT, NIT, WHT 8" L x 4.2" W x 1" H 270 delivered lumens 7 Watts	
	12"	6UCSK12 BZT, NIT, WHT 12" L x 4.2" W x 1" H 400 delivered lumens 9 Watts	
	22"	6UCSK22 BZT, NIT, WHT 22" L x 4.2" W x 1" H 735 delivered lumens 16 Watts	
	30"	6UCSK30 BZT, NIT, WHT 30" L x 4.2" W x 1" H 1000 delivered lumens 19 Watts	
Benefits	Product Benefits <ul style="list-style-type: none"> • Switch fixture from 2700K to 3000K for on-site customization • Quality, diffused light output eliminates hotspots on countertop • 90 CRI keeps furnishings true-to-color • Replaceable driver extends the life of the fixture • Energy efficient, LED light source • FCC compliant and can be used to comply with 2016 Title 24, Part 6 High efficiency LED light source requirements • Dimmable with standard wall dimmer 		Installation Benefits <ul style="list-style-type: none"> • Smaller profile driver creates more access to wiring, helping contractors install jobs faster • Driver can also move to create additional access to wiring • Cable connectors and captive screws ensure installation ease • Direct wire and linkable • Knockouts on end caps for easy connectivity • 1" profile, 4.2" depth • BX connector 10589 included with fixture • See page 9 for under cabinet installation options
Warranty	5-year residential warranty. 3-year commercial warranty. See Kichler.com/warranty for complete details.		
Accessories	See page 9 for complete list. For recommended dimmers visit Kichler.com/dimming .		

4U Series LED

Quality and value lighting for any application.

A low-profile design, durable finish and gently diffused light output make these LED fixtures a true value — ideal for a variety of applications, from single-family homes to multi-unit structures.



Shown: 4U27K12WHT

		Finish, Color Temperature and Size					
Available Finishes	Textured Bronze (BZT), Textured White (WHT)				Available Finishes		
Color Temperature	2700K - Warm White		3000K - Pure White				
Size							
	8"	4U27K08 BZT, WHT 8" L x 4.5" W x 1.1" H 175 delivered lumens 4 Watts	8"	4U30K08 BZT, WHT 8" L x 4.5" W x 1.1" H 200 delivered lumens 4 Watts			
	12"	4U27K12 BZT, WHT 12" L x 4.5" W x 1.1" H 250 delivered lumens 6 Watts	12"	4U30K12 BZT, WHT 12" L x 4.5" W x 1.1" H 285 delivered lumens 6 Watts			
	22"	4U27K22 BZT, WHT 22" L x 4.5" W x 1.1" H 485 delivered lumens 10 Watts	22"	4U30K22 BZT, WHT 22" L x 4.5" W x 1.1" H 560 delivered lumens 10 Watts			
	30"	4U27K30 BZT, WHT 30" L x 4.5" W x 1.1" H 650 delivered lumens 14 Watts	30"	4U30K30 BZT, WHT 30" L x 4.5" W x 1.1" H 750 delivered lumens 14 Watts			
Benefits	Product Benefits <ul style="list-style-type: none"> • Quality, diffused light output • 90 CRI keeps furnishings true-to-color • Replaceable driver extends the life of the fixture • Energy efficient, LED light source • FCC compliant and can be used to comply with 2016 Title 24, Part 6 High efficiency LED light source requirements • Durable powder coat finish • Dimmable with standard wall dimmer 			Installation Benefits <ul style="list-style-type: none"> • Captive screws for quick installation • Direct wire and linkable • Knockouts in sides and in back of fixture • 1.1" profile, 4.5" depth • BX connector 10589 included with fixture • See page 9 for under cabinet installation options 			
Warranty	3-year residential warranty. 1-year commercial warranty. See Kichler.com/warranty for complete details.						
Accessories	See page 9 for complete list. For recommended dimmers visit Kichler.com/dimming .						



Fluorescent

Convenience and value come together.

Kichler® direct wire Fluorescent fixtures combine the energy efficiency of Fluorescent bulbs with the convenience of traditional incandescent fixtures.









Shown: 10041WH

Finish, Color Temperature and Size		
Available Finish	White (WH)	Available Finish
Color Temperature	2700K equivalent	
Size	12.25" 10041 WH 12.25" L x 3.5" W x 1" H T5 Fluorescent lamp included 8 Watts maximum Direct Wire Only	
	21.5" 10042 WH 21.5" L x 3.5" W x 1" H T5 Fluorescent lamp included 13 Watts maximum Direct Wire Only	
	34.5" 10043 WH 34.5" L x 3.5" W x 1" H T5 Fluorescent lamp included 21 Watts maximum Direct Wire Only	
	46.5" 10044 WH 46.5" L x 3.5" W x 1" H T5 Fluorescent lamp included 28 Watts maximum Direct Wire Only	
Benefits	Product Benefits <ul style="list-style-type: none"> • Combines the energy efficiency of Fluorescent lighting with the convenience and popularity of incandescent fixtures • Fully replaceable bulbs 	Installation Benefits <ul style="list-style-type: none"> • Hinged assembly • Multiple knockouts for installation ease • NM & BX single cable connector included • 1" profile, 3.5" depth
Warranty	3-year residential warranty. 1-year commercial warranty. See Kichler.com/warranty for complete details.	
Accessories	See page 9 for complete list.	

Accessories

Link with ease.

Kichler Lighting offers an array of durable cables and connectors to create an interconnected, evenly-powered under cabinet system design.

Under Cabinet Accessories (optional)			
	Accessories	Compatible Fixtures	
Cables & Connectors	10571 BK, WH 9" interconnect cable	6U, 4U LED	
	10572 BK, WH 14" interconnect cable	6U, 4U LED	
	10573 BK, WH 21" interconnect cable	6U, 4U LED	
	10570 BK, WH Wire module 7.75" L x 2.625" W x 1" H	6U, 4U LED	
	10588 SI Duplex BX cable connector	6U, 4U LED, Fluorescent	
	10589 SI (included with fixture) Connector for NM & BX cable	6U, 4U LED, Fluorescent	
	6UCORD BK, WH 60" under cabinet interconnect prong cord	6U, 4U LED	
Bulbs & Lamps	10081 FST 8 Watts, T5	Fluorescent	
	10082 FST 13 Watts, T5	Fluorescent	
	10083 FST 21 Watts, T5	Fluorescent	
	10084 FST 28 Watts, T5	Fluorescent	

Installation

Options that add versatility.

Kichler® 6U and 4U LED under cabinet fixtures can be installed two different ways: either direct wired for installation closer to the wall, or linked together using accessories for installation near the front face of cabinets.



Back of Cabinet Installation – Direct wire connect.



Front Mount – Use wire module and interconnect cable.





LED Tape & Accent Lighting

Don't just add light; integrate it into your design.

Kichler Lighting's newest tape lighting choices bring new depth to design possibilities. Feature light throughout a closet. Take light the length of your longest corridor. Integrate light into a wall as a focal point. Or, illuminate the thinnest of shelves. With a flexible design, ultra-thin profile and channel mounting options, you can create a custom effect from floor to ceiling.



How to Build a System

1

LED Light Sources

8-Series

Commercial
Grade

Voltage - 24V



8T LED Tape Light – 100' Roll *(See page 15 for more options)*

Standard Output	2200K 8T1100S22WH	2700K 8T1100S27WH	3000K 8T1100S30WH	4000K 8T1100S40WH	5000K 8T1100S50WH
High Output	2200K 8T1100H22WH	2700K 8T1100H27WH	3000K 8T1100H30WH	4000K 8T1100H40WH	5000K 8T1100H50WH

6-Series

Premium
Residential

Voltage - 24V



6T LED Tape Light – 100' Roll *(See pages 16 – 18 for more options)*

Standard Output	2700K – 6T1100S27BK,WH	3000K – 6T1100S30BK,WH
High Output	2700K – 6T1100H27BK,WH	3000K – 6T1100H30BK,WH



6HS Hard Strips *(See page 21 for more options)*

6"	2700K – 6HS27K06AL	3000K – 6HS30K06AL
12"	2700K – 6HS27K12AL	3000K – 6HS30K12AL



6D Accent Disc *(See page 20 for more options)*

Textured Black	2700K – 6D24V27BKT	3000K – 6D24V30BKT
Textured Bronze	2700K – 6D24V27BZT	3000K – 6D24V30BZT
Textured Nickel	2700K – 6D24V27NIT	3000K – 6D24V30NIT
Textured White	2700K – 6D24V27WHT	3000K – 6D24V30WHT

4-Series

Residential

Voltage - 12V



4T LED Tape Light – 100' Roll *(See page 19 for more options)*

Standard Output	2700K – 4T1100S27WH	3000K – 4T1100S30WH
-----------------	---------------------	---------------------



4D Accent Disc *(See page 20 for more options)*

Textured Black	2700K – 4D12V27BKT	3000K – 4D12V30BKT
Textured Bronze	2700K – 4D12V27BZT	3000K – 4D12V30BZT
Textured Nickel	2700K – 4D12V27NIT	3000K – 4D12V30NIT
Textured White	2700K – 4D12V27WHT	3000K – 4D12V30WHT

Below are components frequently purchased together to create an accent lighting system. Utilize this guide to draft a quick spec, or refer to the pages that follow for additional sizes or models available in each category.

2 Connectors & Leads



8T Tape Light Connector Accessories

8T1TWR1WH - Tape-to-Wire
8T1TTR1WH - Tape-to-Tape
8T1TWRSWH - Tape-to-Supply Lead

(See page 14 for more options)



Tape Light Power Supply Leads

1SLW8 BK, WH - 8'
1SL8 BK, WH - 8' with DC Jack



Tape Light Interconnects

1IC12 BK, WH - 12" (See pages 25-26 for more options)
1IC36 BK, WH - 36"



Hard Strip Supply Leads

6HS1SL8WH - 8'
6HS1SL8DCWH - 8' with DC Jack



Hard Strip Interconnect

6HS1IC12WH - 12" (See page 21 for more options)

-



Tape Light Power Supply Leads

1SLW8 BK, WH - 8'
1SL8 BK, WH - 8' with DC Jack



Tape Light Interconnects

1IC12 BK, WH - 12" (See page 25-26 for more options)
1IC36 BK, WH - 36"

-

3 Power Supplies

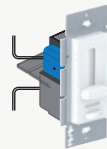

Driver + Dimmer All-in-one Driver and Dimmer Switch

6DD24V100WH - 100W
6DD24V060WH - 60W



Direct Wire Dimmable Drivers

6TD24V60BKT - 60W
6TD24V40BKT - 40W
6TD24V10BKT - 10W



Plug-in Power Supply

10190BK60 - 60W

(See pages 22 - 23 for more options)

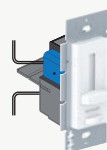

Driver + Dimmer All-in-one Driver and Dimmer Switch

4DD12V060WH - 60W
4DD12V040WH - 40W



Direct Wire Dimmable Drivers

4TD12V60BKT - 60W
4TD12V40BKT - 40W



Plug-in Power Supply

4TP12V60BK - 60W

(See pages 22 - 23 for more options)

4 Accessories



TE-Series Extruded Channels for Tape Light

Standard Depth Surface Mount Kits

1TEK1STSF2SIL - 2'
1TEK1STSF4SIL - 4'
1TEK1STSF8SIL - 8'



Standard Depth Recessed Mount Kits

1TEK1STRC2SIL - 2'
1TEK1STRC4SIL - 4'
1TEK1STRC8SIL - 8'



45-Degree Surface Mount Kits

1TEK145SF2SIL - 2'
1TEK145SF4SIL - 4'
1TEK145SF8SIL - 8'

(See pages 30 - 63 for more options)



Hard Strip Accessories

6HSOCLIPS - 0-degree mounting clips

(See page 21 for more options)



Power supply accessories

10189 BK, WH - Splice Box

(See page 25 for more options)



Plug-in power supply accessories

10198 BK,WH - Inline Dimmer
1DC2 BK,WH - 2-way DC Splitter

1DC3 BK, WH - 3-way DC Splitter

1DCSWITCH BK,WH - Inline DC Low Voltage Switch

(See page 25 for more options)

8T Series 24V LED

The 8T Series of Commercial Grade LED Tape Light is designed to integrate with our patent-pending connector accessory system to simplify and speed up the installation of even the most complicated tape light design configurations. The tape features a flexible 2-layer circuit board that supports increased run lengths with less voltage drop. It then offers a push-in connector base every four inches with cut marks to either side. Eight unique connector accessories can install straight on (0-degrees) or rotated (180-degrees) – regardless of tape direction or polarity – and simply push into place.



Commercial grade, 24/7 operation, and when paired with channels, provides countless design possibilities

- Available in Standard, High, and Ultra High output in 5 color temperatures: 2200K, 2700K, 3000K, 4000K, and 5000K
- An assortment of strips and rolls, ranging from 4" to 100'
- Compatible with 8 unique connector accessories that can decrease installation time in any design configuration
- Flexible 2-layer circuit board for extended run length: 67ft Standard, 33ft High, 10ft Ultra High
- Field-cuttable on marked cut lines on either side of the connector
- Edge-to-edge 3M™ adhesive

8T Series Connector Accessories (Patent Pending)

A robust pluggable tape connector accessory system

- Push in, reliable connection
- Universal polarity at the connector for ease of installation
- Provides 0-180 degree connection
- Tape-to-wire connectors allow the installer to utilize their preferred 20-22AWG wire to make custom length supply leads and jumpers
- Flexible connectors allow connections to bend around corners for new unique installation solutions
- Designed to carry the full load of Standard, High and Ultra High tape light outputs.

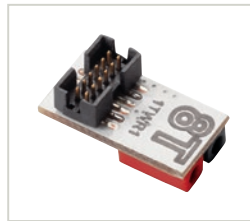

8T1TWR1WH
Tape-to-Wire

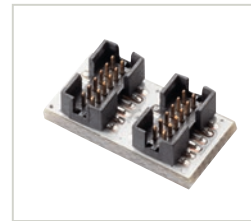

8T1TTR1WH
Tape-to-Tape



8T1TWR5WH
Tape-to-Supply Lead
72" – 18AWG



8T1TWF1WH
Tape-to-Wire, Flex



8T1TTF1WH
Tape-to-Tape, Flex

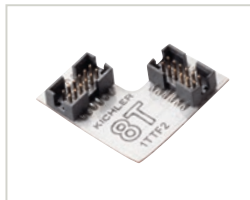

8T1TTF2WH
90° Tape-to-Tape, Flex

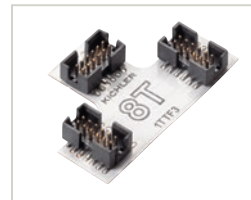

8T1TTF3WH
3-Way Tape-to-Tape, Flex

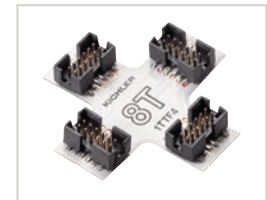

8T1TTF4WH
4-Way Tape-to-Tape, Flex

The ability to build a lighting system is one of the many things that makes low-voltage LED tape and accent lighting so versatile. With the right components, you can install lighting just about anywhere your supply wire can take you, including TE-Series installations in commercial spaces, extensive coves in entertainment venues, and display lighting in retail locations. To build your system, you'll need:

Product + Power Supply + Supply Wire, Leads and Interconnects + Accessories = Light

1
Select your Product



Page 15

+

2
Select your Power Supply



Page 23

+

3
Select Supply Leads and/or Interconnects



Page 14

+

4
Select Wire



Page 27

+

5
Utilize Accessories



Pages 29 – 67
Plus those noted above

	Finish, Color Temperature, Lumens and Size									
Location Use	Dry Locations Only									
Available Finishes	White (WH)									
Color Temperature	2200K - Amber White		2700K - Warm White		3000K - Pure White		4000K - Cool White		5000K - Bright White	
Standard Output • 67' max. linear run length • 95-135 delivered lumens per foot • 1.5W per foot, 90 CRI • Cutable every 4" on either side of connector	4"	8T1000S22WH	4"	8T1000S27WH	4"	8T1000S30WH	4"	8T1000S40WH	4"	8T1000S50WH
	12"	8T1001S22WH	12"	8T1001S27WH	12"	8T1001S30WH	12"	8T1001S40WH	12"	8T1001S50WH
	10'	8T1010S22WH	10'	8T1010S27WH	10'	8T1010S30WH	10'	8T1010S40WH	10'	8T1010S50WH
	67'	8T1067S22WH	67'	8T1067S27WH	67'	8T1067S30WH	67'	8T1067S40WH	67'	8T1067S50WH
	100'	8T1100S22WH	100'	8T1100S27WH	100'	8T1100S30WH	100'	8T1100S40WH	100'	8T1100S50WH
High Output • 33' max. linear run length • 175-220 delivered lumens per foot • 3W per foot, 90 CRI • Cutable every 4" on either side of connector	4"	8T1000H22WH	4"	8T1000H27WH	4"	8T1000H30WH	4"	8T1000H40WH	4"	8T1000H50WH
	12"	8T1001H22WH	12"	8T1001H27WH	12"	8T1001H30WH	12"	8T1001H40WH	12"	8T1001H50WH
	10'	8T1010H22WH	10'	8T1010H27WH	10'	8T1010H30WH	10'	8T1010H40WH	10'	8T1010H50WH
	33'	8T1033H22WH	33'	8T1033H27WH	33'	8T1033H30WH	33'	8T1033H40WH	33'	8T1033H50WH
	100'	8T1100H22WH	100'	8T1100H27WH	100'	8T1100H30WH	100'	8T1100H40WH	100'	8T1100H50WH
Ultra-High Output* • 10' max. linear run length • 410-575 delivered lumens per foot • 7.2W per foot, 90 CRI • Cutable every 4" on either side of connector	10'	8T1010U22WH	10'	8T1010U27WH	10'	8T1010U30WH	10'	8T1010U40WH	10'	8T1010U50WH
	* Ultra-High cannot be used with 12330 plastic track or TE Series Extruded Channels.									
Warranty	5-year residential and commercial warranty. See Kichler.com/warranty for complete details.									
Additional Info	Compatible dimmers will vary based on selected power supply. For recommended dimmers visit Kichler.com/dimming .									







6T Series 24V LED



Kichler® damp LED tape is engineered to perform in areas with moisture exposure. Use behind a bathroom vanity, near a kitchen sink or outdoors in covered areas — such as in a gazebo or roofed patio.



Shown: 6T210H24WH

Finish, Color Temperature, Lumens and Size			
Location Use	Damp Locations		
Available Finish	White (WH)		
Color Temperature	3000K - Pure White**		
Standard Output • 32' max. linear run length • 100 delivered lumens per foot • 1.5W per foot, 90 CRI • Cuttable every 4"	10' 6T210S24WH 15 Watts		
	16' 6T216S24WH 24 Watts		
High Output • 20' max. linear run length • 170 delivered lumens per foot • 3W per foot, 90 CRI • Cuttable every 4"	10' 6T210H24WH 30 Watts		
	20' 6T220H24WH 60 Watts		
Supply Wire	Tape light rolls come with a 2' supply lead connected to the beginning and end of each roll.		
Warranty	5-year residential warranty. 3-year commercial warranty. See Kichler.com/warranty for complete details.		
Additional Info	Compatible dimmers will vary based on selected power supply. For recommended dimmers visit Kichler.com/dimming .		
Accessories	<table border="0" style="width: 100%;"> <tr> <td style="width: 50%; vertical-align: top;"> Damp Tape End Caps 10181 Caps end of cut piece of damp tape  </td> <td style="width: 50%; vertical-align: top;"> Silicone 10183 Use with 10181 damp tape end cap  </td> </tr> </table>	Damp Tape End Caps 10181 Caps end of cut piece of damp tape 	Silicone 10183 Use with 10181 damp tape end cap 
Damp Tape End Caps 10181 Caps end of cut piece of damp tape 	Silicone 10183 Use with 10181 damp tape end cap 		

** Pure White 3100K (+/-200K)

Product + Power Supply + Supply Wire, Leads and Interconnects + Accessories = Light

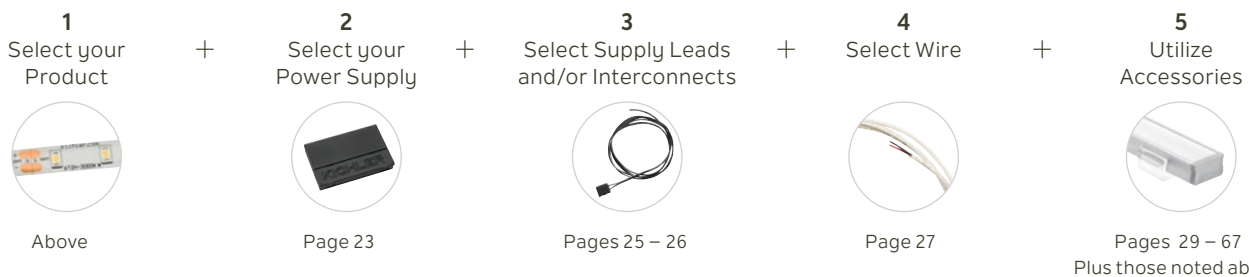

6T Series 24V LED

Choose your color temperature, your ideal wattage and more. The 6T Series brings a lengthy run of illumination to a variety of dry locations and features 3M™ adhesive backing for secure placement, every time.



Shown: 6T110S30WH

	Finish, Color Temperature, Lumens and Size							
Location Use	Dry Locations Only							
Available Finishes	Black (BK), White (WH)							
Color Temperature	2400K - Amber White		2700K - Warm White		3000K - Pure White		5000K - Bright White	
Standard Output • 32' max. linear run length • 120–145 delivered lumens per foot • 1.5W per foot, 90 CRI • Cuttable every 4"	10'	–	10'	6T110S27 BK, WH 15 Watts	10'	6T110S30 BK, WH 15 Watts	10'	–
	16'	6T116S24 BK, WH 24 Watts	16'	6T116S27 BK, WH 24 Watts	16'	6T116S30 BK, WH 24 Watts	16'	6T116S50 BK, WH 24 Watts
	100'	–	100'	6T1100S27 BK, WH	100'	6T1100S30 BK, WH	100'	6T1100S50 BK, WH
High Output • 20' max. linear run length • 215–270 delivered lumens per foot • 3W per foot, 90 CRI • Cuttable every 4"	10'	–	10'	6T110H27 BK, WH 30 Watts	10'	6T110H30 BK, WH 30 Watts	10'	–
	20'	6T120H24 BK, WH 60 Watts	20'	6T120H27 BK, WH 60 Watts	20'	6T120H30 BK, WH 60 Watts	20'	6T120H50 BK, WH 60 Watts
	100'	–	100'	6T1100H27 BK, WH	100'	6T1100H30 BK, WH	100'	6T1100H50 BK, WH
Ultra-High Output • 10' max. linear run length • 490–590 delivered lumens per foot • 7.2W per foot, 90 CRI • Cuttable every 2"	10'	–	10'	6T110UH27 BK, WH 72 Watts	10'	6T110UH30 BK, WH 72 Watts	10'	6T110UH50 BK, WH 72 Watts
	Ultra-High output tape requires soldered connections; doesn't work with tape light supply leads or connectors. Ultra-High cannot be used with 12330 plastic track and TE Extruded Channels							
Supply Wire	Tape light rolls come with a 2' supply wire soldered to the beginning and end of each roll.							
Warranty	5-year residential warranty. 3-year commercial warranty. See Kichler.com/warranty for complete details.							
Additional Info	Compatible dimmers will vary based on selected power supply. For recommended dimmers visit Kichler.com/dimming .							

Follow steps 1 to 5 on the previous page to build your lighting system.



Hint: Most of our 24V compatible power supplies start with the number 6; 12V compatible power supplies start with the number 4.

6T Series 24V RGB LED

We combined the versatility of our 6T Series with color customization. Choose red, green or blue light – or a combination – to add a pop of color to bar areas, retail shelving, mirrors or anywhere you want an enhanced effect.



Shown: 120RGBBK

Finish, Color Temperature, Lumens and Size	
Location Use	Dry Locations Only
Available Finishes	Black (BK), White (WH)
Color-Changing RGB	
High Output • 20' max. linear run length • 4W per foot	20' 120RGB BK, WH 80 Watts Must be used with 10199 BK-RGB Controller.
Controller	<div style="display: flex; align-items: flex-start;"> <div style="flex: 1;"> <p>10199 BK-RGB Controller</p> <ul style="list-style-type: none"> • 9A maximum • Must be used with RGB tape light • Multiple modes for unique light settings • Adjusts speeds and brightness • Connects between power supply and tape light • Works with DC or direct wire inputs </div> <div style="flex: 1; text-align: center;">  </div> </div>
Warranty	5-year residential warranty. 3-year commercial warranty. See Kichler.com/warranty for complete details.
Additional Info	Compatible dimmers will vary based on selected power supply. For recommended dimmers visit Kichler.com/dimming .

To build an RGB system, follow the same steps, adding in the controller between your power supply and tape light. To build your system, you'll need:

Product + Power Supply + Controller + Supply Wire, Leads and Interconnects + Accessories = Light

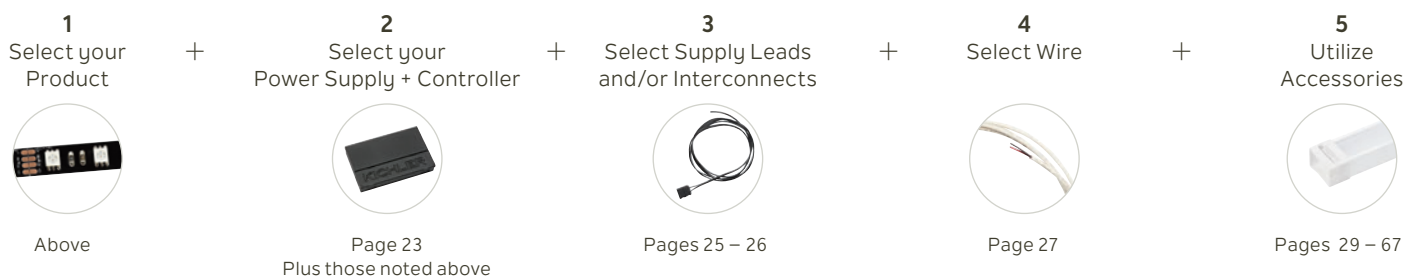

4T Series 12V LED

A low voltage design and the ability to cut to 2" increments makes the 4T Series ideal for short runs and smaller spaces, like lining shelves or cabinets.



Shown: 4T1100H30WH

Finish, Color Temperature, Lumens and Size

Location Use	Dry Locations Only					
Available Finish	White (WH)					
Color Temperature	2700K - Warm White		3000K - Pure White		5000K - Bright White	
Standard Output • 16' max. linear run length • 120–140 delivered lumens per foot • 1.5W per foot, 90 CRI • Cuttable every 2"	16'	4T116S27WH 24 Watts	16'	4T116S30WH 24 Watts	16'	4T116S50WH 24 Watts
	100'	4T1100S27WH	100'	4T1100S30WH	100'	4T1100S50WH
High Output • 16' max. linear run length • 210–260 delivered lumens per foot • 3W per foot, 90 CRI • Cuttable every 2"	16'	4T116H27WH 48 Watts	16'	4T116H30WH 48 Watts	16'	4T116H50WH 48 Watts
	100'	4T1100H27WH	100'	4T1100H30WH	100'	4T1100H50WH
Supply Wire	Tape light rolls come with a 2' supply wire soldered to the beginning and end of each roll.					
Warranty	3-year residential warranty. 1-year commercial warranty. See Kichler.com/warranty for complete details.					
Additional Info	Compatible dimmers will vary based on selected power supply. For recommended dimmers visit Kichler.com/dimming .					

Product + Power Supply + Supply Wire, Leads and Interconnects + Accessories = Light



























Accent Discs

6D Series 24V LED / 4D Series 12V LED

Get a stunning 190 lumens of output with just 4 Watts of power: the Kichler® LED accent disc delivers a pure and softly diffused infusion of light inside cabinetry as a decorative accent.



Shown: 4D12V27WHT

Finish, Color Temperature, Size and Accessories																								
Location Use	Damp Locations - Enclosed Cabinets must be at least 12" D x 12" W x 12" H																							
Available Finishes	Textured Black (BKT), Textured Bronze (BZT), Textured Nickel (NIT), Textured White (WHT)																							
Color Temperature	<table border="1"> <tr> <th>2700K - Warm White</th> <th>3000K - Pure White</th> </tr> <tr> <td> <table border="1"> <tr> <td>2.7"</td> <td> 6D24V27, 4D12V27 BKT, BZT, NIT, WHT 2.7" W x 0.6" H 190 lumens 4 Watt 90(+) CRI </td> </tr> <tr> <td>2.7"</td> <td> 6D24V30, 4D12V30 BKT, BZT, NIT, WHT 2.7" W x 0.6" H 190 lumens 4 Watts 90(+) CRI </td> </tr> </table> </td> <td> <table border="1"> <tr> <td>  <p>BKT</p> </td> <td>  <p>BZT</p> </td> <td>  <p>NIT</p> </td> <td>  <p>WHT</p> </td> </tr> </table> </td> </tr> <tr> <td>Model #</td> <td> <table border="1"> <tr> <td> • 24V (6D) • 12V (4D) </td> <td> 6D24V27, 4D12V27 BKT, BZT, NIT, WHT 2.7" W x 0.6" H 190 lumens 4 Watt 90(+) CRI </td> <td> 6D24V30, 4D12V30 BKT, BZT, NIT, WHT 2.7" W x 0.6" H 190 lumens 4 Watts 90(+) CRI </td> </tr> </table> </td> </tr> <tr> <td>Benefits</td> <td> <table border="1"> <tr> <td> Product Benefits <ul style="list-style-type: none"> • Surface mount design works well inside glass-faced kitchen cabinetry, china cabinets or curio cabinets that need light for accent or display purposes. • Recessed mount design is ideal for open-top shelves/cabinets. • Two Kelvin temperature options (2700K or 3000K) allow you to customize the light to the space. • Choose from four durable powder-coated finishes. • Premium frosted lens diffuses light cleanly and seamlessly for a "spotlight-free" effect. • 90(+) CRI </td> <td> Installation Benefits <ul style="list-style-type: none"> • Each puck comes with 6' of blunt-cut wire; customize your length as needed — no bunching up the wires in tight spaces. • Use a splice box to connect multiple pucks, or to combine with LED tape, on the same power supply (12V-to-12V, 24V-to-24V). • Eliminate voltage drops on long runs; use the wire that matches your needs: <ul style="list-style-type: none"> • 24 AWG wire allows for a 40-foot run • 18 AWG wire allows for a 170-foot run (best used as a trunk wire to allow for longer runs) </td> </tr> </table> </td> </tr> <tr> <td>Warranty</td> <td>3-year residential warranty. 1-year commercial warranty. See Kichler.com/warranty for complete details.</td> </tr> </table>	2700K - Warm White	3000K - Pure White	<table border="1"> <tr> <td>2.7"</td> <td> 6D24V27, 4D12V27 BKT, BZT, NIT, WHT 2.7" W x 0.6" H 190 lumens 4 Watt 90(+) CRI </td> </tr> <tr> <td>2.7"</td> <td> 6D24V30, 4D12V30 BKT, BZT, NIT, WHT 2.7" W x 0.6" H 190 lumens 4 Watts 90(+) CRI </td> </tr> </table>	2.7"	6D24V27, 4D12V27 BKT, BZT, NIT, WHT 2.7" W x 0.6" H 190 lumens 4 Watt 90(+) CRI	2.7"	6D24V30, 4D12V30 BKT, BZT, NIT, WHT 2.7" W x 0.6" H 190 lumens 4 Watts 90(+) CRI	<table border="1"> <tr> <td>  <p>BKT</p> </td> <td>  <p>BZT</p> </td> <td>  <p>NIT</p> </td> <td>  <p>WHT</p> </td> </tr> </table>	 <p>BKT</p>	 <p>BZT</p>	 <p>NIT</p>	 <p>WHT</p>	Model #	<table border="1"> <tr> <td> • 24V (6D) • 12V (4D) </td> <td> 6D24V27, 4D12V27 BKT, BZT, NIT, WHT 2.7" W x 0.6" H 190 lumens 4 Watt 90(+) CRI </td> <td> 6D24V30, 4D12V30 BKT, BZT, NIT, WHT 2.7" W x 0.6" H 190 lumens 4 Watts 90(+) CRI </td> </tr> </table>	• 24V (6D) • 12V (4D)	6D24V27, 4D12V27 BKT, BZT, NIT, WHT 2.7" W x 0.6" H 190 lumens 4 Watt 90(+) CRI	6D24V30, 4D12V30 BKT, BZT, NIT, WHT 2.7" W x 0.6" H 190 lumens 4 Watts 90(+) CRI	Benefits	<table border="1"> <tr> <td> Product Benefits <ul style="list-style-type: none"> • Surface mount design works well inside glass-faced kitchen cabinetry, china cabinets or curio cabinets that need light for accent or display purposes. • Recessed mount design is ideal for open-top shelves/cabinets. • Two Kelvin temperature options (2700K or 3000K) allow you to customize the light to the space. • Choose from four durable powder-coated finishes. • Premium frosted lens diffuses light cleanly and seamlessly for a "spotlight-free" effect. • 90(+) CRI </td> <td> Installation Benefits <ul style="list-style-type: none"> • Each puck comes with 6' of blunt-cut wire; customize your length as needed — no bunching up the wires in tight spaces. • Use a splice box to connect multiple pucks, or to combine with LED tape, on the same power supply (12V-to-12V, 24V-to-24V). • Eliminate voltage drops on long runs; use the wire that matches your needs: <ul style="list-style-type: none"> • 24 AWG wire allows for a 40-foot run • 18 AWG wire allows for a 170-foot run (best used as a trunk wire to allow for longer runs) </td> </tr> </table>	Product Benefits <ul style="list-style-type: none"> • Surface mount design works well inside glass-faced kitchen cabinetry, china cabinets or curio cabinets that need light for accent or display purposes. • Recessed mount design is ideal for open-top shelves/cabinets. • Two Kelvin temperature options (2700K or 3000K) allow you to customize the light to the space. • Choose from four durable powder-coated finishes. • Premium frosted lens diffuses light cleanly and seamlessly for a "spotlight-free" effect. • 90(+) CRI 	Installation Benefits <ul style="list-style-type: none"> • Each puck comes with 6' of blunt-cut wire; customize your length as needed — no bunching up the wires in tight spaces. • Use a splice box to connect multiple pucks, or to combine with LED tape, on the same power supply (12V-to-12V, 24V-to-24V). • Eliminate voltage drops on long runs; use the wire that matches your needs: <ul style="list-style-type: none"> • 24 AWG wire allows for a 40-foot run • 18 AWG wire allows for a 170-foot run (best used as a trunk wire to allow for longer runs) 	Warranty	3-year residential warranty. 1-year commercial warranty. See Kichler.com/warranty for complete details.
2700K - Warm White	3000K - Pure White																							
<table border="1"> <tr> <td>2.7"</td> <td> 6D24V27, 4D12V27 BKT, BZT, NIT, WHT 2.7" W x 0.6" H 190 lumens 4 Watt 90(+) CRI </td> </tr> <tr> <td>2.7"</td> <td> 6D24V30, 4D12V30 BKT, BZT, NIT, WHT 2.7" W x 0.6" H 190 lumens 4 Watts 90(+) CRI </td> </tr> </table>	2.7"	6D24V27, 4D12V27 BKT, BZT, NIT, WHT 2.7" W x 0.6" H 190 lumens 4 Watt 90(+) CRI	2.7"	6D24V30, 4D12V30 BKT, BZT, NIT, WHT 2.7" W x 0.6" H 190 lumens 4 Watts 90(+) CRI	<table border="1"> <tr> <td>  <p>BKT</p> </td> <td>  <p>BZT</p> </td> <td>  <p>NIT</p> </td> <td>  <p>WHT</p> </td> </tr> </table>	 <p>BKT</p>	 <p>BZT</p>	 <p>NIT</p>	 <p>WHT</p>															
2.7"	6D24V27, 4D12V27 BKT, BZT, NIT, WHT 2.7" W x 0.6" H 190 lumens 4 Watt 90(+) CRI																							
2.7"	6D24V30, 4D12V30 BKT, BZT, NIT, WHT 2.7" W x 0.6" H 190 lumens 4 Watts 90(+) CRI																							
 <p>BKT</p>	 <p>BZT</p>	 <p>NIT</p>	 <p>WHT</p>																					
Model #	<table border="1"> <tr> <td> • 24V (6D) • 12V (4D) </td> <td> 6D24V27, 4D12V27 BKT, BZT, NIT, WHT 2.7" W x 0.6" H 190 lumens 4 Watt 90(+) CRI </td> <td> 6D24V30, 4D12V30 BKT, BZT, NIT, WHT 2.7" W x 0.6" H 190 lumens 4 Watts 90(+) CRI </td> </tr> </table>	• 24V (6D) • 12V (4D)	6D24V27, 4D12V27 BKT, BZT, NIT, WHT 2.7" W x 0.6" H 190 lumens 4 Watt 90(+) CRI	6D24V30, 4D12V30 BKT, BZT, NIT, WHT 2.7" W x 0.6" H 190 lumens 4 Watts 90(+) CRI																				
• 24V (6D) • 12V (4D)	6D24V27, 4D12V27 BKT, BZT, NIT, WHT 2.7" W x 0.6" H 190 lumens 4 Watt 90(+) CRI	6D24V30, 4D12V30 BKT, BZT, NIT, WHT 2.7" W x 0.6" H 190 lumens 4 Watts 90(+) CRI																						
Benefits	<table border="1"> <tr> <td> Product Benefits <ul style="list-style-type: none"> • Surface mount design works well inside glass-faced kitchen cabinetry, china cabinets or curio cabinets that need light for accent or display purposes. • Recessed mount design is ideal for open-top shelves/cabinets. • Two Kelvin temperature options (2700K or 3000K) allow you to customize the light to the space. • Choose from four durable powder-coated finishes. • Premium frosted lens diffuses light cleanly and seamlessly for a "spotlight-free" effect. • 90(+) CRI </td> <td> Installation Benefits <ul style="list-style-type: none"> • Each puck comes with 6' of blunt-cut wire; customize your length as needed — no bunching up the wires in tight spaces. • Use a splice box to connect multiple pucks, or to combine with LED tape, on the same power supply (12V-to-12V, 24V-to-24V). • Eliminate voltage drops on long runs; use the wire that matches your needs: <ul style="list-style-type: none"> • 24 AWG wire allows for a 40-foot run • 18 AWG wire allows for a 170-foot run (best used as a trunk wire to allow for longer runs) </td> </tr> </table>	Product Benefits <ul style="list-style-type: none"> • Surface mount design works well inside glass-faced kitchen cabinetry, china cabinets or curio cabinets that need light for accent or display purposes. • Recessed mount design is ideal for open-top shelves/cabinets. • Two Kelvin temperature options (2700K or 3000K) allow you to customize the light to the space. • Choose from four durable powder-coated finishes. • Premium frosted lens diffuses light cleanly and seamlessly for a "spotlight-free" effect. • 90(+) CRI 	Installation Benefits <ul style="list-style-type: none"> • Each puck comes with 6' of blunt-cut wire; customize your length as needed — no bunching up the wires in tight spaces. • Use a splice box to connect multiple pucks, or to combine with LED tape, on the same power supply (12V-to-12V, 24V-to-24V). • Eliminate voltage drops on long runs; use the wire that matches your needs: <ul style="list-style-type: none"> • 24 AWG wire allows for a 40-foot run • 18 AWG wire allows for a 170-foot run (best used as a trunk wire to allow for longer runs) 																					
Product Benefits <ul style="list-style-type: none"> • Surface mount design works well inside glass-faced kitchen cabinetry, china cabinets or curio cabinets that need light for accent or display purposes. • Recessed mount design is ideal for open-top shelves/cabinets. • Two Kelvin temperature options (2700K or 3000K) allow you to customize the light to the space. • Choose from four durable powder-coated finishes. • Premium frosted lens diffuses light cleanly and seamlessly for a "spotlight-free" effect. • 90(+) CRI 	Installation Benefits <ul style="list-style-type: none"> • Each puck comes with 6' of blunt-cut wire; customize your length as needed — no bunching up the wires in tight spaces. • Use a splice box to connect multiple pucks, or to combine with LED tape, on the same power supply (12V-to-12V, 24V-to-24V). • Eliminate voltage drops on long runs; use the wire that matches your needs: <ul style="list-style-type: none"> • 24 AWG wire allows for a 40-foot run • 18 AWG wire allows for a 170-foot run (best used as a trunk wire to allow for longer runs) 																							
Warranty	3-year residential warranty. 1-year commercial warranty. See Kichler.com/warranty for complete details.																							

Product + Power Supply + Supply Wire + Accessories = Light



Hard Strips 24V LED

A rigid exterior and quick connect end-caps make Hard Strips easy to install in linear applications, such as behind a work of art. Plus, their low profile and light diffusing shell offer a versatile option for under cabinet and display lighting applications.

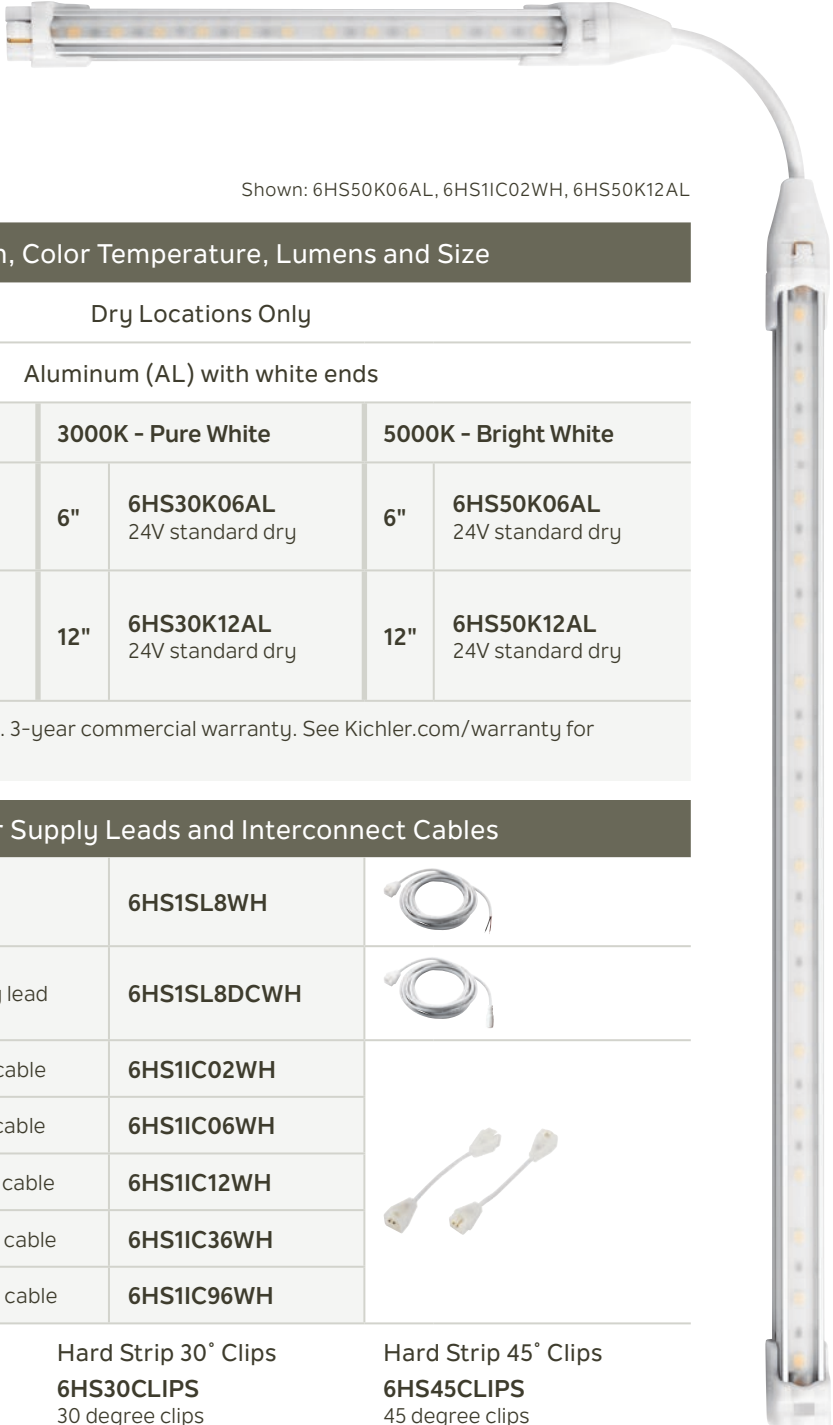

Shown: 6HS50K06AL, 6HS1IC02WH, 6HS50K12AL

Finish, Color Temperature, Lumens and Size						
Location Use	Dry Locations Only					
Available Finish	Aluminum (AL) with white ends					
Color Temperature	2700K - Warm White		3000K - Pure White		5000K - Bright White	
Standard Output • 10' max. linear run length • 200–240 delivered lumens per foot • 6" unit = 2.7W • 12" unit = 4W • 90 CRI	6"	6HS27K06AL 24V standard dry	6"	6HS30K06AL 24V standard dry	6"	6HS50K06AL 24V standard dry
	12"	6HS27K12AL 24V standard dry	12"	6HS30K12AL 24V standard dry	12"	6HS50K12AL 24V standard dry
Warranty	5-year residential warranty. 3-year commercial warranty. See Kichler.com/warranty for complete details.					

Power Supply Leads and Interconnect Cables			
Power Supply Leads Connects Hard Strip to power supply. Cannot be used as an interconnect cable.	8' Hard Strip supply lead	6HS1SL8WH	
	8' Hard Strip DC jack supply lead	6HS1SL8DCWH	
Interconnect Cables Used to connect two Hard Strips together.	2" Hard Strip interconnect cable	6HS1IC02WH	
	6" Hard Strip interconnect cable	6HS1IC06WH	
	12" Hard Strip interconnect cable	6HS1IC12WH	
	36" Hard Strip interconnect cable	6HS1IC36WH	
	96" Hard Strip interconnect cable	6HS1IC96WH	
Accessories One set of each mounting clip comes included with the fixture.	Hard Strip 0° Clips 6HS0CLIPS 0 degree clips 	Hard Strip 30° Clips 6HS30CLIPS 30 degree clips 	Hard Strip 45° Clips 6HS45CLIPS 45 degree clips 









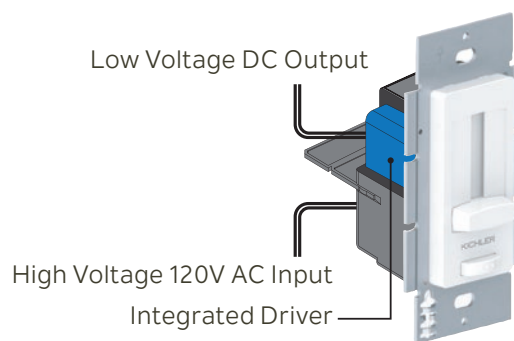

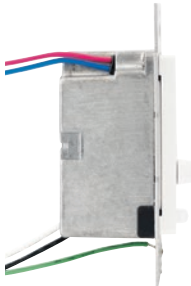

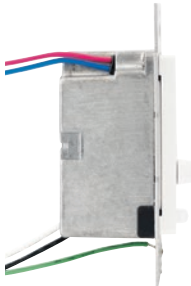

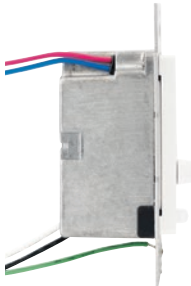

To Build a Hard Strips System, you'll need:

Product (above) + **Power Supply** (page 23) + **Supply Leads & Interconnects** (above) + **Wire** (page 27) = **Light**

LED Driver + Dimmer

The Kichler® all-in-one LED Driver + Dimmer simplifies your lighting systems installation. By integrating the driver with the dimmer switch, this one product can convert 120V AC to either 12V or 24V DC, as well as dim from 100% to 1%. Simply connect this one device to both your high voltage input and low voltage output and install with a standard single gang box to the wall – saving time on installation.



Models and Accessories													
Location Use	Dry Locations Only*												
Available Finish	White (WH)												
Benefits	<div style="display: flex; justify-content: space-between;"> <div style="width: 45%;"> <p>Product Benefits</p> <ul style="list-style-type: none"> • All-in-one integrated LED Driver + Dimmer switch eliminates switch/driver compatibility issues. • Pre-set dimmer with on/off switch offers excellent dimming performance: 100%-1%. • Manages 120V AC input to control 12V or 24V constant voltage lighting systems. </div> <div style="width: 45%;"> <p>Installation Benefits</p> <ul style="list-style-type: none"> • Eliminates the time and guesswork of finding compatible options. • All-in-one product saves time in ordering, tracking, and installing over multiple components. • Installs in a standard single-gang wall box. </div> </div>												
Compatible Fixtures	4T Series 12V, 4D Series 12V, 6T Series 24V Dry, 6T Series 24V Damp*, 6D Series 24V, Hard Strips 24V												
Warranty	5-year limited warranty. See Kichler.com/warranty for complete details.												
Build a System	To build a complete lighting system select from the following: Product (pages 14-21) + Power Supply (below) + Leads & Interconnects (pages 25-26) + Accessories (below)												
Power Supply Models SELV Trim plate sold separately.	<table border="1"> <tbody> <tr> <td rowspan="2">12V</td> <td>4DD12V040WH 12V 40W with white face plate</td> <td rowspan="4">   </td> </tr> <tr> <td>4DD12V060WH 12V 60W with white face plate</td> </tr> <tr> <td rowspan="2">24V</td> <td>6DD24V060WH 24V 60W with white face plate</td> </tr> <tr> <td>6DD24V100WH 24V 100W with white face plate</td> </tr> </tbody> </table>	12V	4DD12V040WH 12V 40W with white face plate	 	4DD12V060WH 12V 60W with white face plate	24V	6DD24V060WH 24V 60W with white face plate	6DD24V100WH 24V 100W with white face plate					
12V	4DD12V040WH 12V 40W with white face plate		 										
	4DD12V060WH 12V 60W with white face plate												
24V	6DD24V060WH 24V 60W with white face plate												
	6DD24V100WH 24V 100W with white face plate												
Accessories Trim and face plate together.	<table border="1"> <thead> <tr> <th>Light Almond (ALM)</th> <th>Black (BK)</th> <th>Brown (BW)</th> <th>White (WH)</th> </tr> </thead> <tbody> <tr> <td>1DDTRIMALM</td> <td>1DDTRIMBK</td> <td>1DDTRIMBW</td> <td>1DDTRIMWH</td> </tr> <tr> <td></td> <td></td> <td></td> <td></td> </tr> </tbody> </table>	Light Almond (ALM)	Black (BK)	Brown (BW)	White (WH)	1DDTRIMALM	1DDTRIMBK	1DDTRIMBW	1DDTRIMWH				
Light Almond (ALM)	Black (BK)	Brown (BW)	White (WH)										
1DDTRIMALM	1DDTRIMBK	1DDTRIMBW	1DDTRIMWH										
													

*Provisions can be made to connect to damp tape. Consult our APS team by visiting Kichler.com/APS.

Power Supplies

Whether you choose to hardwire your system or plug it in to an existing outlet, Kichler® power supplies deliver consistent, reliable energy, helping to maintain the life of the lighting fixtures.

Power Supplies			
			Compatible Fixtures
Plug-In Power Supply* Simple and Economical, plug-in drivers are the basic power supply.	4TP12V30BK 30W	8' of cord with male DC 2.1 jack on end	4T Series 12V
	4TP12V60BK 60W		4T Series 12V
	10190BK30 30W	2.4W minimum load requirement	8T Series 24V 6T Series 24V Dry 6T Series 24V Damp 6T Series 24V RGB Hard Strips 24V
	10190BK48 48W	120V–240V input	
	10190BK60 60W	Must be installed in dry location	
Direct Wire Dimmable Power Supplies* Lower Watt: Economical driver ideal for smaller, direct wire, low voltage system projects. CL and ELV dimmer compatible.** Higher Watt: Ideal for larger direct wire projects (i.e., combining multiple products). CL and ELV dimmer compatible.** All Kichler® Direct Wire Dimmable power supplies include wiring compartments. No additional NEMA enclosure required.	4TD12V40BKT 40W dimmable LED power supply		4T Series 12V 4D Series 12V
	6TD24V10BKT 10W dimmable LED power supply		8T Series 24V 6T Series 24V Dry 6T Series 24V Damp 6T Series 24V RGB 6D Series 24V Hard Strips 24V
	6TD24V40BKT 40W dimmable LED power supply		
	4TD12V60BKT 60W dimmable LED power supply	4T Series 12V 4D Series 12V	
	6TD24V60BKT 60W dimmable LED power supply		8T Series 24V 6T Series 24V Dry 6T Series 24V Damp 6T Series 24V RGB 6D Series 24V
	6TD24V96BKT 96W dimmable LED power supply		
	10193BK 8' cord and plug accessory		
	LED Driver + Dimmer* See page 22 for details.	4DD12V040WH 12V 40W with white face plate	
4DD12V060WH 12V 60W with white face plate			
6DD24V060WH 24V 60W with white face plate		8T Series 24V 6T Series 24V Dry 6T Series 24V Damp 6D Series 24V Hard Strips 24V	
6DD24V100WH 24V 100W with white face plate			

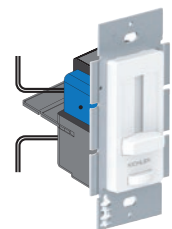

*All Power Supplies are Class 2 and either 12V or 24V DC.

**Compatible dimmers will vary based on selected power supply. For recommended dimmers visit Kichler.com/dimming.

Choosing the Right Power Supplies

PLUG-IN POWER SUPPLIES

Plug-in power supplies are your least expensive option in terms of both cost and labor. Simply connect a 1SL DC jack supply lead to your tape light and a plug-in power supply and you are ready to power your tape light from any receptacle. The max wattage on a plug-in power supply is typically lower than direct wire power supplies, therefore, plug-ins are more ideal for smaller projects. Also, unless prior planning allows for the outlet to be hidden, the cord to the nearest outlet might be visible.

DIRECT WIRE DIMMABLE POWER SUPPLIES

Direct wire dimmable power supplies offer voltage control to help manage the power to your LED lighting system – ultimately maintaining the life of the product. These power supplies have an integrated wiring component – so no additional NEMA accessory component is required. This type of power supply will be mid-tier in terms of expense (cost + labor) as it requires prior planning and access to wall wiring. However, a greater amount of lighting can be connected to higher wattage models - maximizing the number of power supplies needed per design. Those with lower wattage are ideal for islands or small jobs to avoid having to run additional wire to remote installations.

LED DRIVER + DIMMER

Having a driver + dimmer in one may seemingly appear to be the most expensive option; however, it is a quite cost-effective option. With the driver + dimmer in one, you are purchasing, stocking, and installing one item – eliminating the need to install a dimmer separately. The driver + dimmer in one also reduces time spent selecting a compatible dimmer as that has been done for you.

Voltage Drops

For best performance and lumen output, ensure proper wire gauge is installed to compensate for voltage drop of low voltage circuits.

12V Voltage Drop & Wire Length Distance Chart

	5W 0.42A	10W 0.83A	20W 1.67A	30W 2.5A	40W 3.33A	50W 4.17A	60W 5A
18 AWG	65 ft.	32 ft.	16 ft.	10 ft.	8 ft.	6 ft.	5 ft.
16 AWG	100 ft.	50 ft.	25 ft.	16 ft.	12 ft.	10 ft.	8 ft.
14 AWG	160 ft.	79 ft.	39 ft.	26 ft.	20 ft.	16 ft.	13 ft.
12 AWG	240 ft.	120 ft.	59 ft.	39 ft.	30 ft.	24 ft.	20 ft.
10 AWG	392 ft.	196 ft.	98 ft.	65 ft.	49 ft.	39 ft.	32 ft.





- 1 Determine load size.** Let's assume the load is 55W. Round up to the nearest load.
- 2 Determine distance from power supply to load.** Let's assume the distance is 32 ft. Round up to the nearest distance.
- 3 See the recommended wire gauge** to install to eliminate excess voltage drop. Recommended wire gauge is 10AWG.

24V Voltage Drop & Wire Length Distance Chart

	5W 0.21A	10W 0.42A	20W 0.83A	30W 1.25A	40W 1.67A	50W 2.08A	60W 2.5A	70W 2.92A	80W 3.33A	90W 3.75A	100W 4.17A
18 AWG	261 ft.	130 ft.	65 ft.	43 ft.	32 ft.	26 ft.	21 ft.	18 ft.	16 ft.	14 ft.	13 ft.
16 AWG	401 ft.	200 ft.	100 ft.	66 ft.	50 ft.	40 ft.	33 ft.	28 ft.	25 ft.	22 ft.	20 ft.
14 AWG	639 ft.	319 ft.	160 ft.	106 ft.	79 ft.	63 ft.	53 ft.	45 ft.	39 ft.	35 ft.	31 ft.
12 AWG	959 ft.	479 ft.	240 ft.	160 ft.	120 ft.	95 ft.	79 ft.	68 ft.	59 ft.	53 ft.	47 ft.
10 AWG	1570 ft.	785 ft.	392 ft.	261 ft.	196 ft.	157 ft.	130 ft.	112 ft.	98 ft.	87 ft.	78 ft.

Power Supply Leads

Connecting your low voltage system together requires the right supply leads and interconnect accessories. These allow you to link your tape to another run, to low voltage wire or to the power supply.

Power Supply Leads and Inline Accessories				
Available Finishes	Black (BK), White (WH)			
				Compatible Fixtures
Power Supply Leads Connects tape light to power supplies or controls. Cannot be used as an interconnect cable.	2' DC jack supply lead	Dry	1SL2 BK, WH	6T Series 24V 4T Series 12V*
			1SL2RGB BK, WH	6T Series 24V RGB
		Damp	2SL2 WH	6T Series 24V Damp
	8' DC jack supply lead	Dry	1SL8 BK, WH	6T Series 24V 4T Series 12V*
			1SL8RGB BK, WH	6T Series 24V RGB
		Damp	2SL8 WH	6T Series 24V Damp
	2' supply lead No DC connector	Dry	1SLW2 BK, WH	6T Series 24V 4T Series 12V*
		Damp	2SLW2 WH	6T Series 24V Damp
8' supply lead No DC connector	Dry	1SLW8 BK, WH	6T Series 24V 4T Series 12V*	
	Damp	2SLW8 WH	6T Series 24V Damp	
Splice Box Intended for low voltage connections only.	10189 BK, WH Accepts max. 14 AWG wire (4) 3/8" size K.O. 2.375" L x 2.375" W x 1" H Must be installed in dry location		6T Series 24V Dry 6T Series 24V Damp 6T Series 24V RGB 6D Series 24V 4T Series 12V 4D Series 12V Hard Strips 24V	
Inline Dimmer For 12V or 24V output side of power supply.	10198 BK, WH 0–100% dimming 48W max. For indoor use only		6T Series 24V Dry 4T Series 12V Hard Strips 24V	
Inline DC Splitter	1DC2 BK, WH 2-way DC splitter		6T Series 24V Dry 4T Series 12V Hard Strips 24V	
	1DC3 BK, WH 3-way DC splitter		6T Series 24V Dry 4T Series 12V Hard Strips 24V	
Switches	1DCSWITCH BK, WH Inline DC low voltage switch		6T Series 24V Dry 4T Series 12V Hard Strips 24V	





*4T Series only available in White (WH)

Interconnect Cables

Connectors and Interconnect Cables

Available Finishes

Black (BK), White (WH)

				Compatible Fixtures	
Interconnects Used to connect two sections of tape light together or for making tight turns.	Inline splice	Dry	1C1 BK, WH	4T Series 12V*, 6T Series 24V	
			1C1RGB BK, WH	6T Series 24V RGB	
		Damp	2C1 WH	6T Series 24V Damp	
	2" interconnect cable	Dry	1IC02 BK, WH	4T Series 12V*, 6T Series 24V	
			1IC02RGB BK, WH	6T Series 24V RGB	
		Damp	2IC02 WH	6T Series 24V Damp	
	6" interconnect cable	Dry	1IC06 BK, WH	4T Series 12V*, 6T Series 24V	
		Damp	2IC06 WH	6T Series 24V Damp	
	12" interconnect cable	Dry	1IC12 BK, WH	4T Series 12V*, 6T Series 24V	
			1IC12RGB BK, WH	6T Series 24V RGB	
		Damp	2IC12 WH	6T Series 24V Damp	
	36" interconnect cable	Dry	1IC36 BK, WH	4T Series 12V*, 6T Series 24V	
1IC36RGB BK, WH			6T Series 24V RGB		
Damp		2IC36 WH	6T Series 24V Damp		
96" interconnect cable	Dry	1IC96 BK, WH	4T Series 12V*, 6T Series 24V		
		1IC96RGB BK, WH	6T Series 24V RGB		
	Damp	2IC96 WH	6T Series 24V Damp		

*4T Series only available in White (WH)

Low Voltage Wire

Kichler® in-wall rated wire not only helps you keep unsightly wires hidden – it also does it cost effectively. Because our 14 AWG, 16 AWG, and 18 AWG wires are braided, they're slimmer and more flexible than comparable gauge wires – meaning less hassle during installation. Kichler® wire is also compliant with the National Electrical Safety Standards for in-wall lighting and can reduce bill of material costs over that of Romex™. These wires are ideal for use with 12V tape, 24V tape, hard strips or accent discs.

In-Wall Rated Wire



5W14G250WH
14 AWG low voltage wire – 250' CL3P rated



5W16G250WH
16 AWG low voltage wire – 250' CMP rated



5W18G250WH
18 AWG low voltage wire – 250' CM rated



5W14G500WH
14 AWG low voltage wire – 500' CL3P rated



5W16G500WH
16 AWG low voltage wire – 500' CMP rated



5W18G500WH
18 AWG low voltage wire – 500' CM rated

In-Wall NEC rated wire types and applications

Low voltage, in-wall rated wire comes in many forms that work together to create a versatile lighting system. General purpose wire in common areas can connect to another floor utilizing riser or plenum wire. Plenum-rated wire can be used throughout drop ceilings where ventilation requires higher standards.

CM	Communications general purpose cable is best suited for common areas – the open areas in which we live and work. So, when looking for in-wall wire for cabinet-to-cabinet, hanging shelf or other non-plenum or non-riser (vertical between floors) installations, this option works well.
CMP	Communications plenum cable offers a flame retardant coating that makes the product suitable for spaces above dropped ceilings or below raised floors that are used for heating ventilation or air conditioning.
CL3P	Class 3 plenum cable allows the wire to take on higher levels of voltage (300V) than Class 2 (150V). This plenum-rated product is suitable for spaces above dropped ceilings or below raised floors that are used for heating ventilation or air conditioning.

Low Voltage Wire - Class 2 Rated

The best choice outside of the wall: 24 AWG.

This low voltage wire works perfectly for any Class 2 wiring project, since the 24 AWG wire is durable enough to be soldered when you choose not to use connectors. It's also the best option for Kichler® ultra-high output tape.



5W24G250 BK, WH
24 AWG low voltage wire 250'
CL2 rated
Not for in-wall use



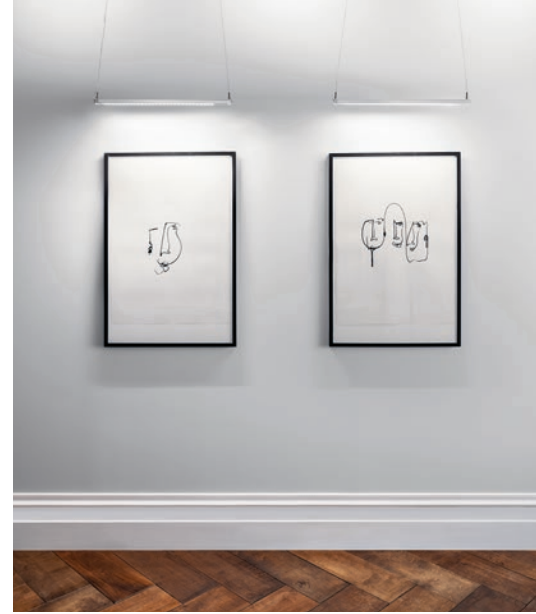

Extruded Channels for Tape Light

Design with Light.

Extruded aluminum channels bring more design versatility to a tape light installation than ever before. With many configurations, you can incorporate lighting throughout nearly any surface: from standard surface mount installations to the recessed integration of light into ceilings, walls and floors. Channels also work to protect LEDs and offer various depth and lens options to achieve a desired end effect.



TE Pro Series – Overview

The Kichler® TE Pro Series of aluminum extruded tape channels will inspire you to design with light. Create eye-catching lighting effects like wall washes, crown ceiling lighting, or durable in-floor designs. Integrate lighting with purpose along corridors and steps, or even closet rods. Or, use the channels to create sleek lighting fixtures like linear sconces and pendants. Metal end caps are offered in this series to assure a polished look.

Sleek (Page 32)



Rod (Page 34)



In-Wall Mud-In (Page 36)

Standard

Deep

Extra Wide / Deep



Cove (Page 38)

Direct

Indirect



Crown (Page 40)

Molding – Contemporary

Molding – Transitional



Arches (Page 42)

Ceiling-to-Wall



Ceiling-Edge



Center-in-Ceiling



Sconce (Page 44)

Sconce – Single Sided



Sconce – Double Sided



Corridor (Page 46)

Corridor – Broad/Transitional



Corridor – Thin/Contemporary



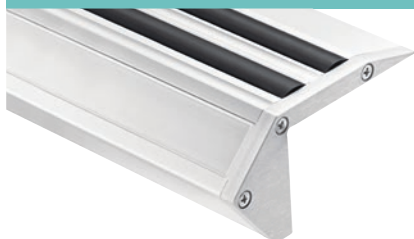

Tread (Page 48)



Floor (Page 49)

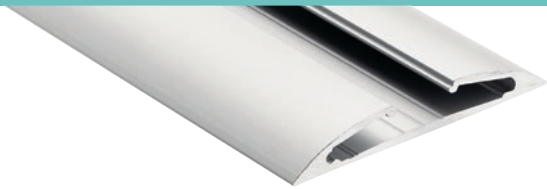
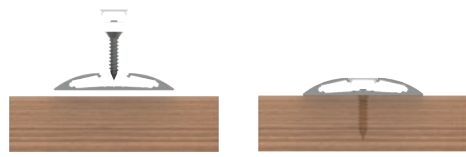
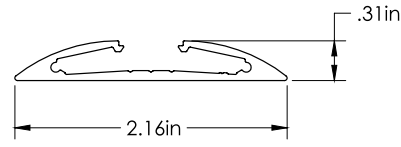

TE Pro Series – Sleek

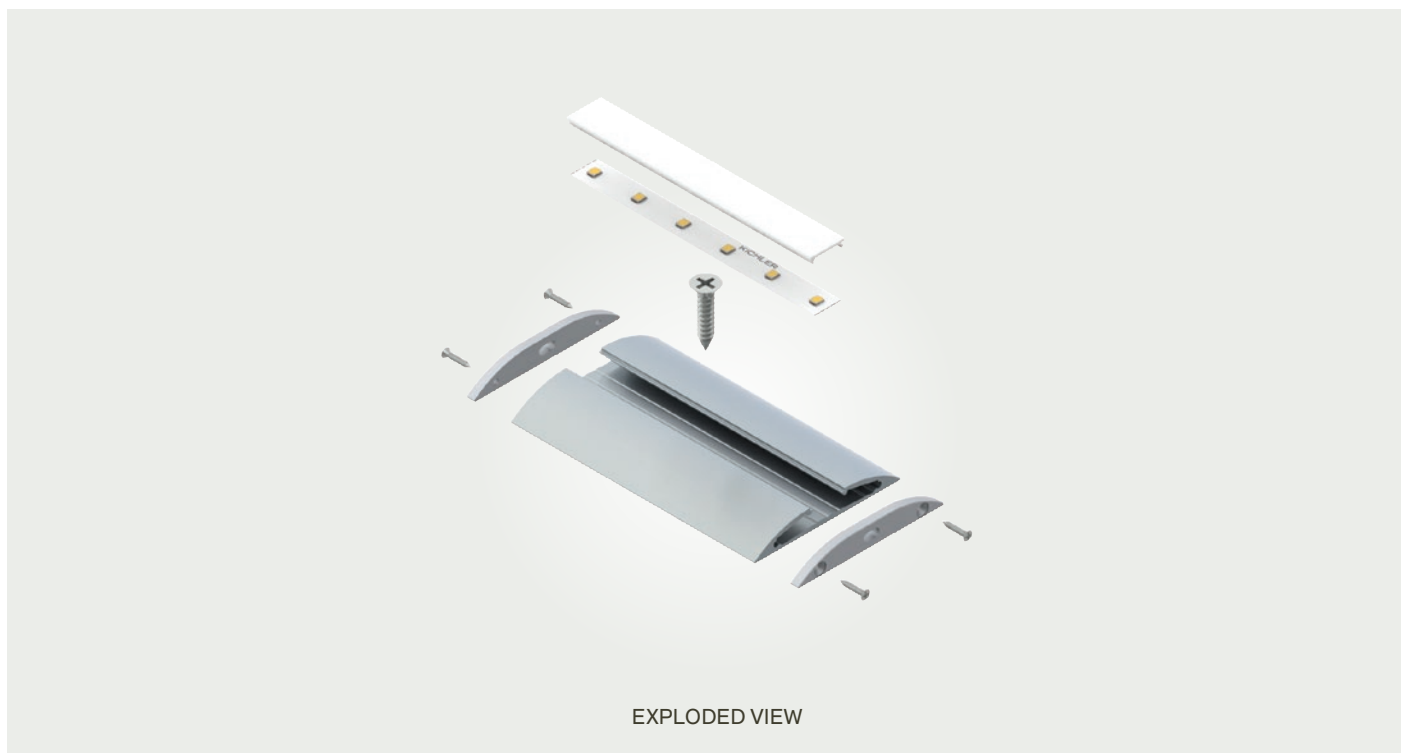

Sleek	
Channel	
Installation View	
Tape Capacity	<ul style="list-style-type: none"> Utilizes one strip of LED tape.
Description	<ul style="list-style-type: none"> This ultra-thin channel with subtly curved edges discreetly installs under modern cabinets or shelves where there is no underside edge. <p>Ideal for:</p> <ul style="list-style-type: none"> Modern, frameless cabinetry Entertainment centers
Dimensions	
A La Carte To Build A Channel With the TE Pro Series, you build your own channel system. Tape Light Sold Separately.	 <p style="text-align: center;"> Channel + Lens + End Caps </p>
Channels 8ft	1TEC1SKSF8SIL
Lenses 8ft	1TEL0018WHO Flat White Opaque 1TEL0018CLR Flat Clear 1TEL1518CLR Narrow Beam Lens, Clear 1TEL3018CLR Medium Beam Lens, Clear
End Caps 2 total	1TEE1SKSFSSIL Metal with Wiring Hole
Mounting	Mount using appropriate hardware for the installation (screws). (See illustration on next page).
Accessories	-

Compatible with Kichler Standard Output (1.5W/ft) and High Output (3W/ft) LED Tape Light.

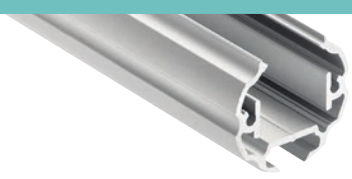
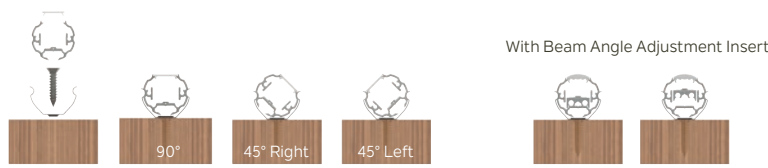
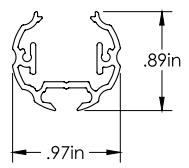

EXPLODED VIEW

TE Pro Series – Rod

Rod	
Channel	
Installation View	
Tape Capacity	<ul style="list-style-type: none"> Utilizes one strip of LED tape
Description	<ul style="list-style-type: none"> An aluminum channel sturdy enough to use as a closet rod. Versatile with its accessories, it can install as a surface mount or pendant to create a unique, directional lighting effect. <p>Ideal for:</p> <ul style="list-style-type: none"> Closets – When paired with closet-rated tape light Suspended architectural accents
Dimensions	
A La Carte To Build A Channel	 <p>Channel + Lens + End Caps + Mounting Clips + Accessories</p>
With the TE Pro Series, you build your own channel system. Tape Light Sold Separately.	
Channels 8ft	1TEC1RDSF8SIL
Lenses 8ft	1TEL0018WHO Flat White Opaque 1TEL0018CLR Flat Clear 1TEL1518CLR Narrow Beam Lens, Clear 1TEL3018CLR Medium Beam Lens, Clear
End Caps 2 total	1TEE1RDSFSSIL Metal with Wiring Hole
Mounting Clips	1TEM1RDSFSCH 10 total
Accessories	1TEA1RDSFBCCH Basic Collar, Standard Closet Install, Mounts to Wall 1TEA1RDSFHCCCH High Closed Collar (Mounts below shelf – Overall Height 3") 1TEA1RDSFHCOCH High Open Collar (Mounts below shelf – Overall Height 3") 1TEA1RDSFLCCCH Low Closed Collar (Mounts below shelf – Overall Height 2.25") 1TEA1RDSFLCOCH Low Open Collar (Mounts below shelf – Overall Height 2.25") 1TEA1RDSFBAESIL Adjustment Beam, End Cap Pair* <i>See illustration on next page</i> 1TEA1RDADJ8SIL Adjustment Beam, LED Insert* <i>See illustration on next page</i> 1TEA090VCONN 90° Vertical Connector Bracket 1TEA090HCONN 90° Horizontal Connector 1TEA120HCONN 120° Horizontal Connector 1TEA180HCONN Straight Connector

*Soldered connections required due to moving parts.

Compatible with Kichler Standard Output (1.5W/ft) and High Output (3W/ft) LED Tape Light.

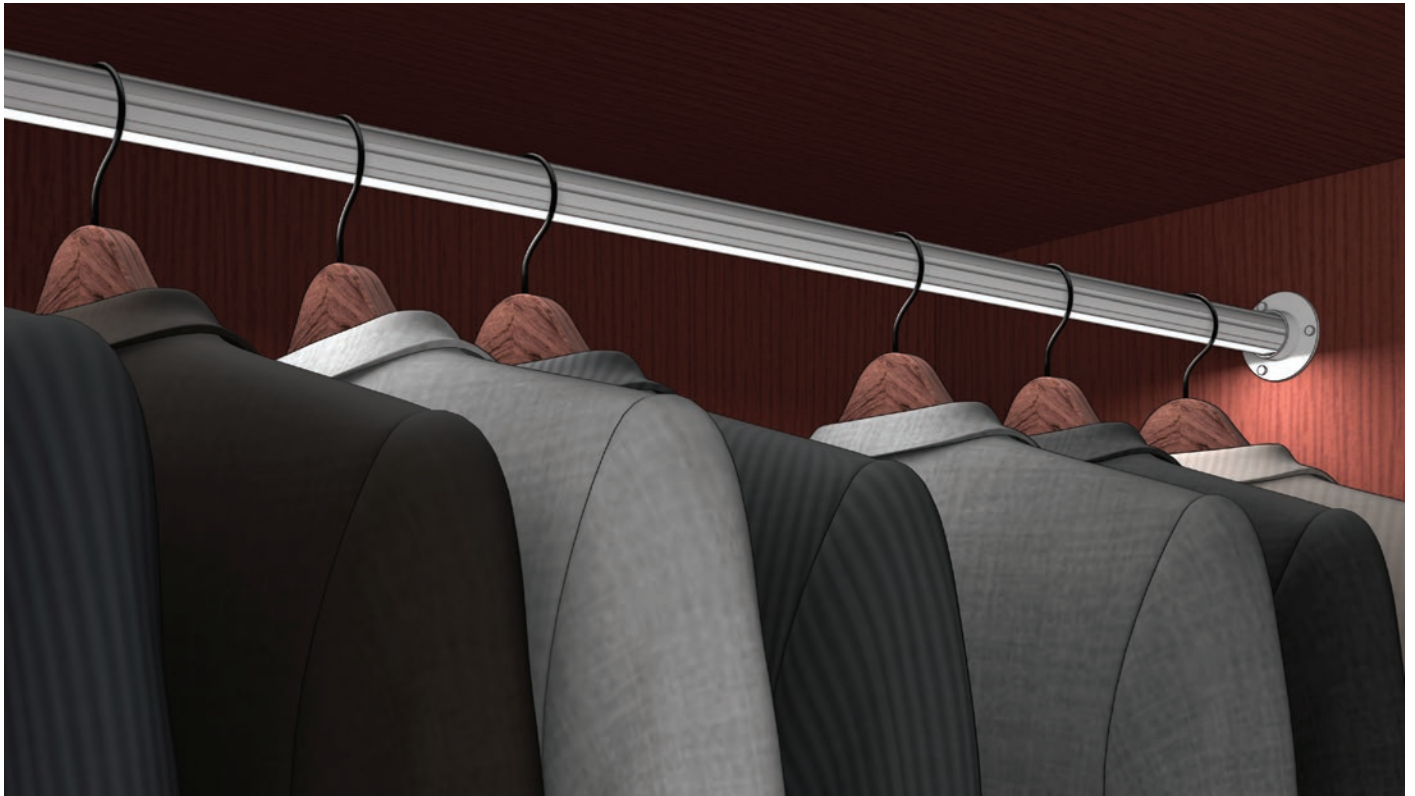

Basic Installation

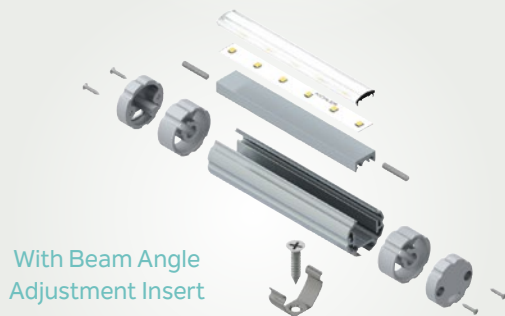

With Beam Angle Adjustment Insert

EXPLODED VIEW

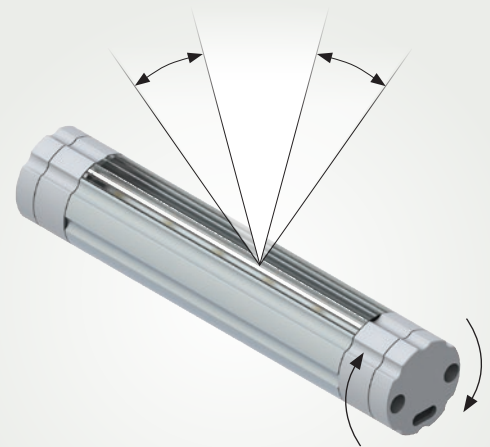





Rotate End Cap to adjust light spread when used with Accessory Beam Adjusting Insert and Beam Adjusting End Caps.

INSTALLATION VIEW

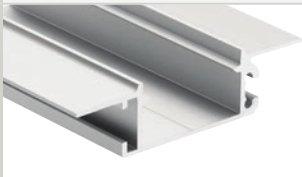
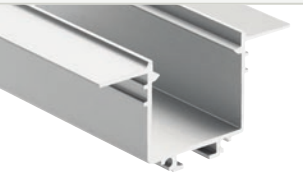
TE Pro Series – In-Wall Mud-In

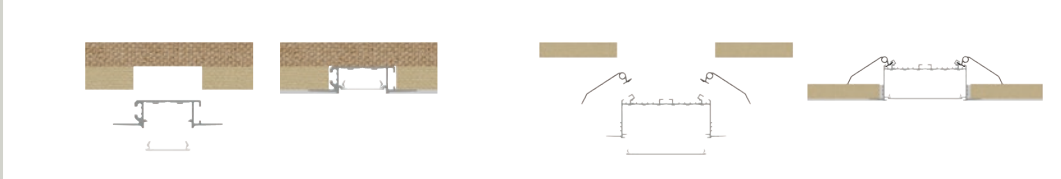
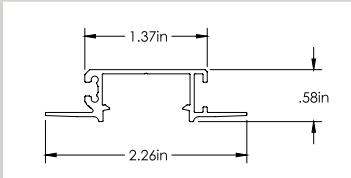
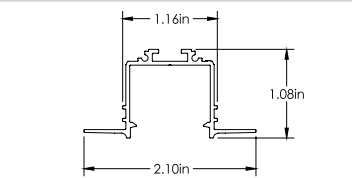
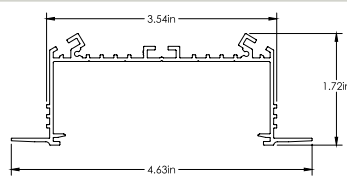
These recessed channels can be incorporated into ceiling or wall designs. Once set in place, drywall mud can be applied over the flange, right up to the trim to create a nearly seamless, built-in aesthetic. Choose from varying channel depths and widths to achieve the desired lighting effect for your design.

In-Wall Mud-In					
	Standard	Deep	Extra Wide / Deep		
Channel					
Installation View					
Tape Capacity	• Utilizes two strips of LED Tape		• Utilizes six strips of LED Tape		
Description	<p>Recessed into wall or ceiling – more of an architectural accent than a true source of light. Grooves along each side and under the flange allow for adhesive or construction cement to ensure a secure installation. Mounting spring clips secure to drywall. Wide flanges allow channel to be mudded and disappear into drywall applications to create a minimalistic look.</p>				
	<p>Ideal for: Incorporating light as a modern architectural accent into a ceiling or wall.</p>	<p>Ideal for: Wall and ceiling architectural accents where the deep well is utilized to create a more uniform dispersion of light.</p>	<p>Ideal for: Creating thin, recessed troffer-like fixtures of varying lengths (utilize connector brackets to elongate, or trim to shorten).</p>		
Dimensions					
A La Carte To Build A Channel					
	Channel	Lens	End Caps	Mounting Clips	Accessories
Channels 8ft	1TEC2SMRC8SIL	1TEC2DMRC8SIL	1TEC6EMRC8SIL		
Lenses 8ft	1TEL0028WHO 2-Tape Wide Flat Lens, White Opaque		1TEL0068WHO 6-Tape Wide Flat Lens, White Opaque		
End Caps 2 Total	1TEE2SMRCSSIL Metal with Wiring Hole	1TEE2DMRCSSIL Metal with Wiring Hole	1TEE6EMRCSSIL Metal with Wiring Hole		
Mounting Clips 10 Total	–		1TEMSC1RC Spring Clip		
Accessories	<p>1TEA090VCONN 90° Vertical Connector Bracket</p> <p>1TEA090HCONN 90° Horizontal Connector Bracket</p> <p>1TEA120HCONN 120° Horizontal Connector Bracket</p> <p>1TEA180HCONN Straight Connector Bracket</p>				

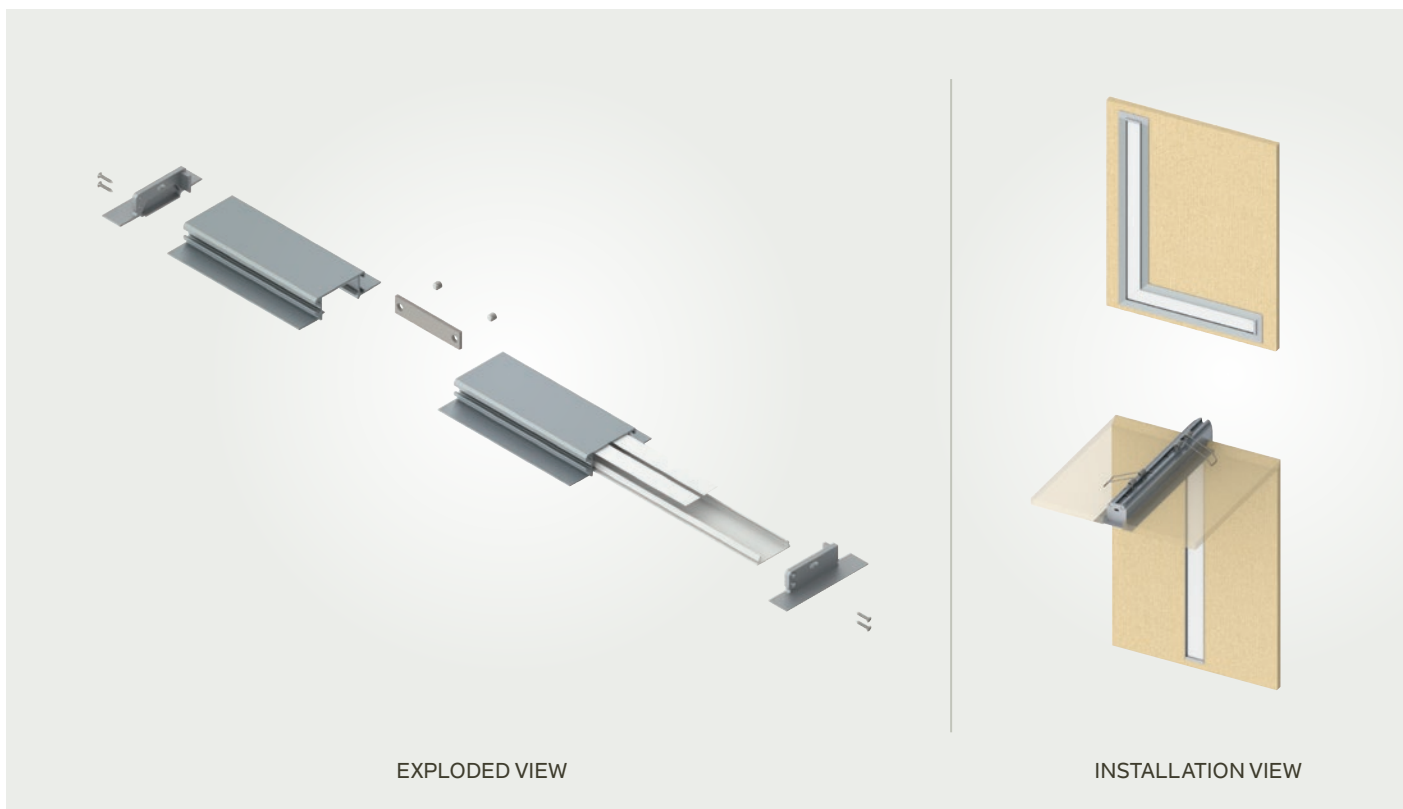



EXPLODED VIEW

INSTALLATION VIEW

TE Pro Series – Cove

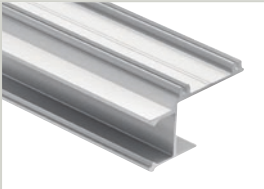
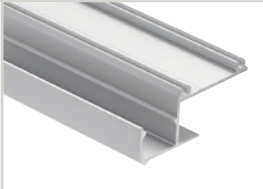
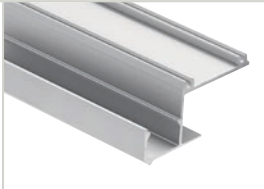
Cove channels wrap the drywall edge of cove ceilings, resulting in a unique accent lighting effect. Drywall mud can be applied over the lower flange to seamlessly integrate the lighting into the cove.

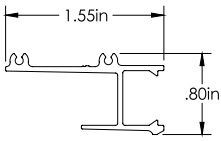
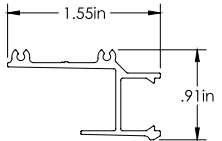
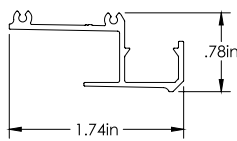
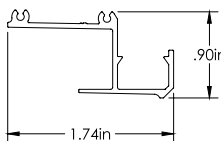
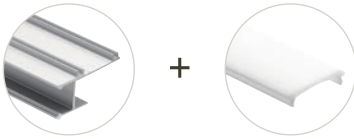
Cove Ceiling				
	Direct 1 (1/2" drywall)	Direct 2 (5/8" drywall)	Indirect 1 (1/2" drywall)	Indirect 2 (5/8" drywall)
Channel				
Installation View				
Tape Capacity	<ul style="list-style-type: none"> Utilizes one strip of LED tape 			
Description	<ul style="list-style-type: none"> Standard depth, direct cove channel that creates a visible light source wrapping the edge of the cove. 		<ul style="list-style-type: none"> Standard depth channel that displays an upward-facing light around a cove to create an indirect lighting effect. 	
	<ul style="list-style-type: none"> Fits 1/2" drywall size 	<ul style="list-style-type: none"> Fits 5/8" drywall size 	<ul style="list-style-type: none"> Fits 1/2" drywall size 	<ul style="list-style-type: none"> Fits 5/8" drywall size
	Ideal for: <ul style="list-style-type: none"> Direct (outward facing) cove lighting effect. 		Ideal for: <ul style="list-style-type: none"> Indirect (upward facing) cove lighting effect. 	
Dimensions				
A La Carte To Build A Channel With the TE Pro Series, you build your own channel system. Tape Light Sold Separately.	 Channel + Lens			
Channels 8ft	1TEC1DC1DW8SIL 1/2" Drywall wrap	1TEC1DC2DW8SIL 5/8" Drywall wrap	1TEC1IC1DW8SIL 1/2" Drywall	1TEC1IC2DW8SIL 5/8" Drywall
Lenses 8ft	1TEL0018WHO Flat White Opaque 1TEL0018CLR Flat Clear 1TEL1518CLR Narrow Beam Lens, Clear 1TEL3018CLR Medium Beam Lens, Clear			

Compatible with Kichler Standard Output (1.5W/ft) and High Output (3W/ft) LED Tape Light.

DIRECT





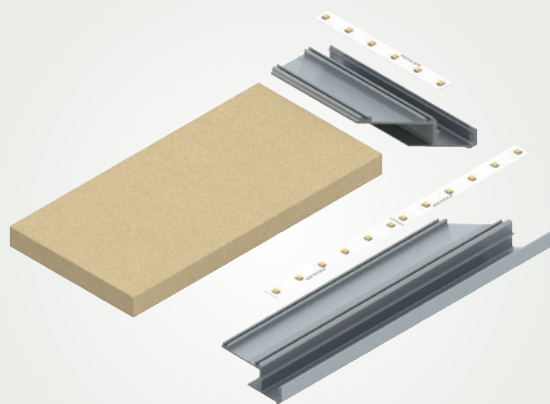





INDIRECT

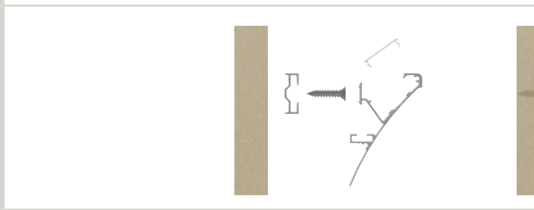
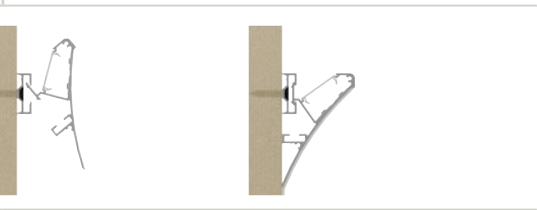
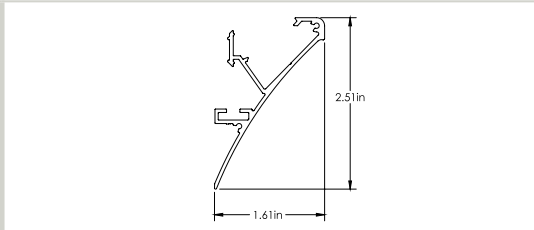
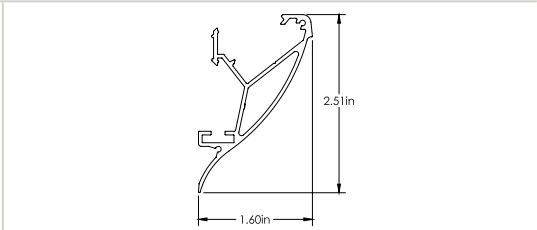

INSTALLATION VIEW

TE Pro Series – Crown

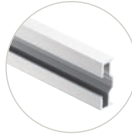
These crown molding channels easily mount to a wall's surface utilizing a mounting extrusion. Available in two styles – transitional or contemporary – each channel delivers a vibrant glow for a lighted crown molding effect. With options to mud up to the flange, paint, or maintain the look of the anodized silver finish, these channels bring versatility to any design.

		Crown							
		Molding – Contemporary	Molding – Transitional						
Channel									
Installation View									
Tape Capacity	• Utilizes two strips of LED tape								
Description	• The smooth, sleek curve of this crown molding offers a modern aesthetic to a room's perimeter.		• Featuring subtle design elements, this transitional crown molding will complement a variety of spaces.						
	Ideal for: • Lighted crown molding for homes or light commercial spaces • Highlight architecture or artwork								
Dimensions									
A La Carte To Build A Channel With the TE Pro Series, you build your own channel system. Tape Light Sold Separately.		+		+		+		+	
Channels 8ft	1TEC2M1SF8SIL		1TEC2M2SF8SIL						
Lenses 8ft	1TEL0028WHO 2-Tape Wide Flat Lens, White Opaque								
End Caps 2 total	1TEE2M1SFSIL Metal with Wiring Hole		1TEE2M2SFSSIL Metal with Wiring Hole						
Mounting Extrusion 8 ft	1TEMME1SF8SIL Crown Channel Mounting Extrusion								
Accessories	1TEA090VCONN 90° Vertical Connector Bracket								
	1TEA090HCONN 90° Horizontal Connector Bracket								
	1TEA120HCONN 120° Horizontal Connector Bracket								
	1TEA180HCONN Straight Connector Bracket								

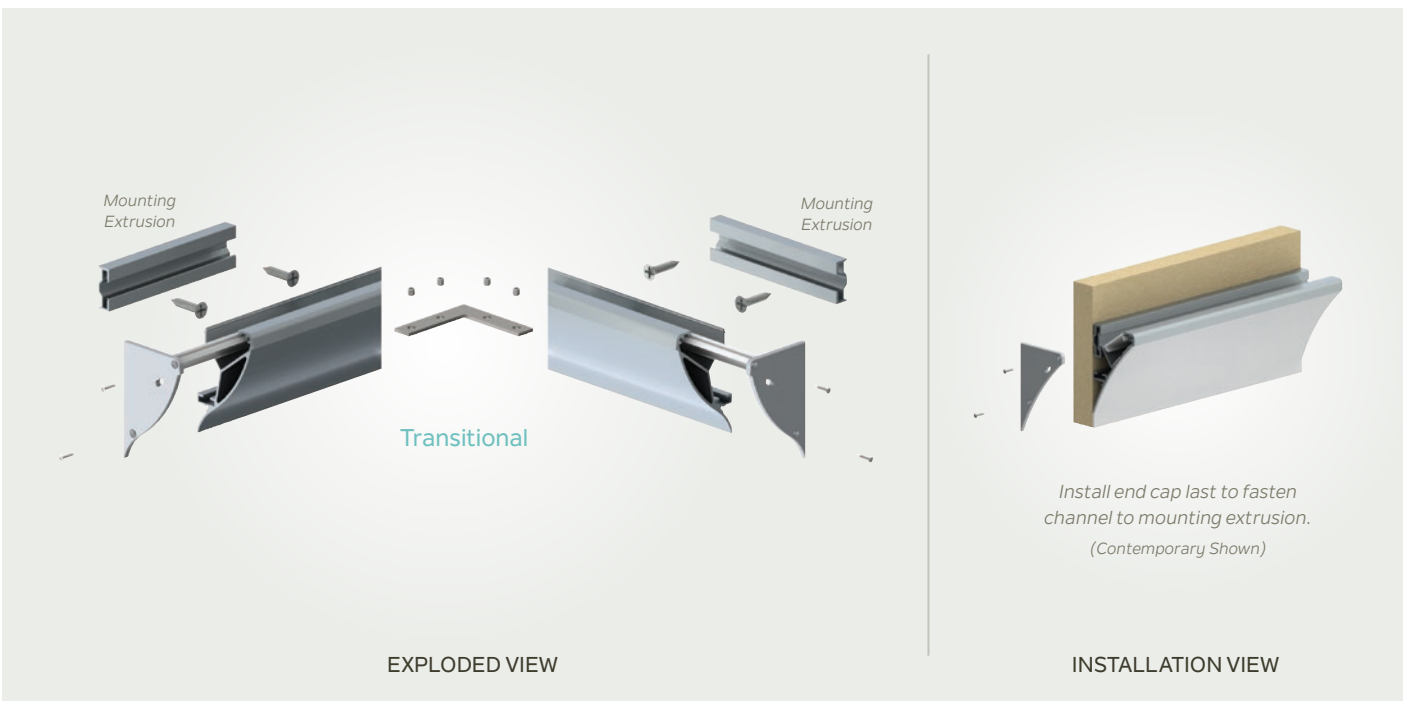

TE Pro Series – Arches



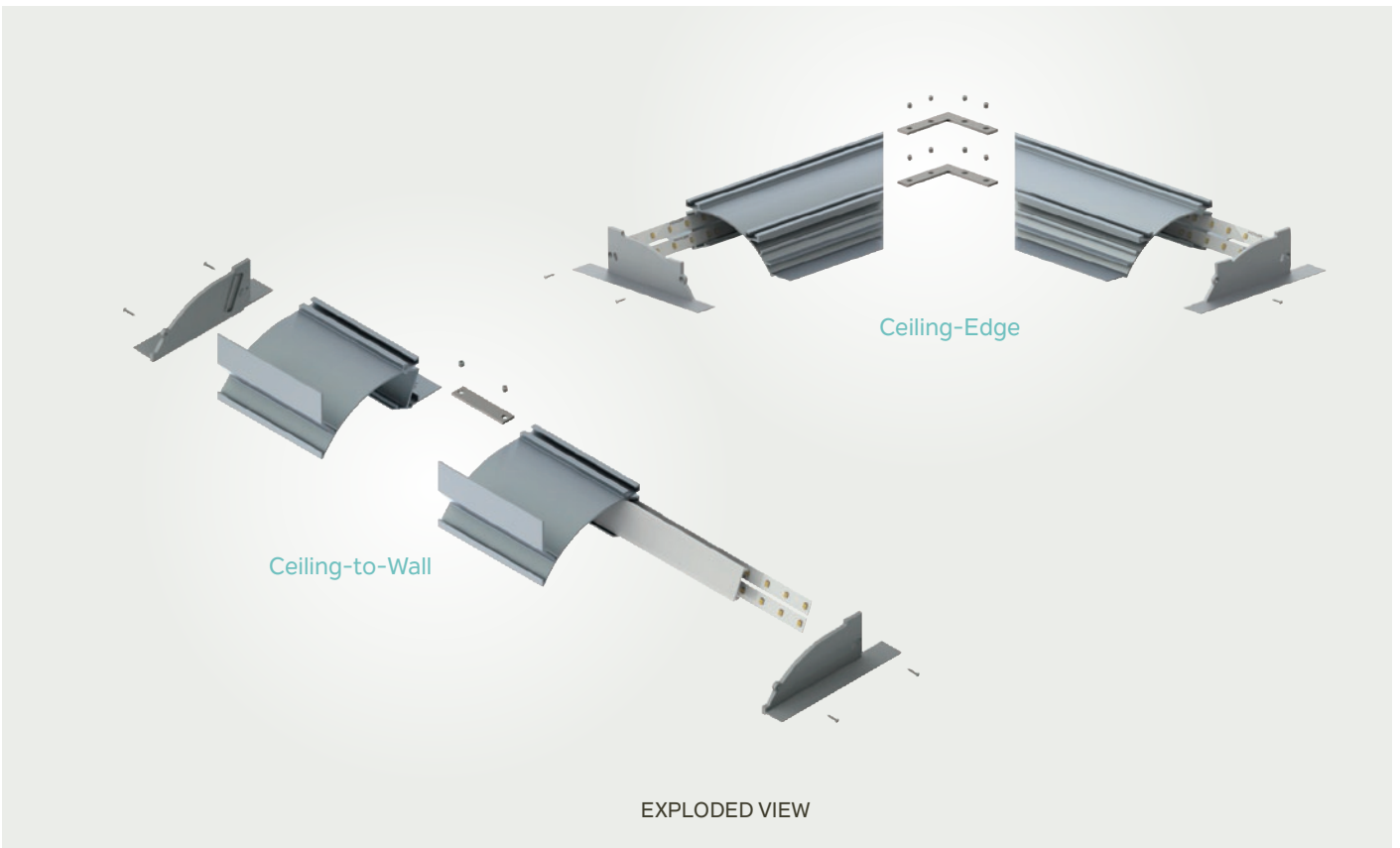

Arches are a recessed collection of channels that are ideal for ceiling installations, but can install on walls as well. Their unique shape positions the tape light facing a reflective arch to create a cove-like, or even edge-lit lighting effect. Light enters the channel and is then distributed both down and out. Wide flanges allow drywall mud to be applied to the trim for a built-in aesthetic.

	Arches		
	Ceiling-to-Wall	Ceiling-Edge	Center-in-Ceiling
Channel			
Installation View			
Tape Capacity	• Utilizes two strips of LED Tape		• Utilizes four strips of LED Tape
Description	<ul style="list-style-type: none"> • One side of the recessed channel affixes to the wall, while the other to the ceiling utilizing mounting spring clips. Light is directed from the ceiling end into the arch and is reflected onto the wall for a crown-like lighting effect. 	<ul style="list-style-type: none"> • Both edges of the recessed channel install in the ceiling or wall - often along the perimeter - utilizing mounting spring clips. Light is then directed from one edge into the arch and is reflected down for an indirect cove-like lighting effect. 	<ul style="list-style-type: none"> • Both edges of the recessed channel install within the ceiling utilizing mounting spring clips. Light is then directed from both edges of the channel into the center of the arch to create a blended, edge-lit appearance of light.
	Ideal for: • Creating perimeter accent lighting.	Ideal for: • Creating a dramatic, indirect accent lighting effect in a ceiling or walls.	Ideal for: • Creating a ceiling (or wall) installation featuring a symmetrical delivery of light.
Dimensions			
A La Carte To Build A Channel			
With the TE Pro Series, you build your own channel system. Tape Light Sold Separately.			
Channels 8ft	1TEC2W1RC8SIL	1TEC2W2RC8SIL	1TEC4W3RC8SIL
Lens 8ft	1TEL0028WHO 2-Tape Wide Flat Lens, White Opaque (Note: 1TEC4W3RC8SIL requires 2 lenses)		
End Caps 2 total	1TEE2W1RCSSIL Metal with Wiring Hole	1TEE2W2RCSSIL Metal with Wiring Hole	1TEE4W3RCSSIL Metal with Wiring Hole
Mounting Clips 10 total	1TEMSC1RC Spring Clip		
Accessories	1TEA090VCONN 90° Vertical Connector Bracket 1TEA090HCONN 90° Horizontal Connector Bracket 1TEA120HCONN 120° Horizontal Connector Bracket 1TEA180HCONN Straight Connector Bracket		

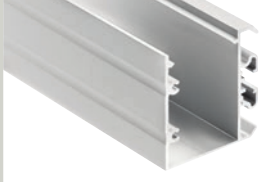

TE Pro Series – Sconces

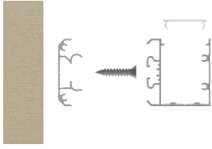
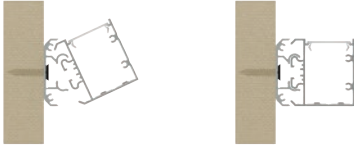
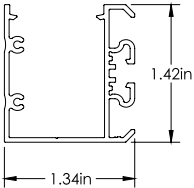
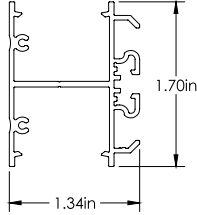
This versatile channel collection can be installed vertically or horizontally to create a customized wall sconce or bath bar. Utilize the mounting extrusion to simplify a surface mount installation, or suspend as a pendant with the pendant cable accessory. The collection offers options to deliver light in a single direction, or from both sides of the channel.

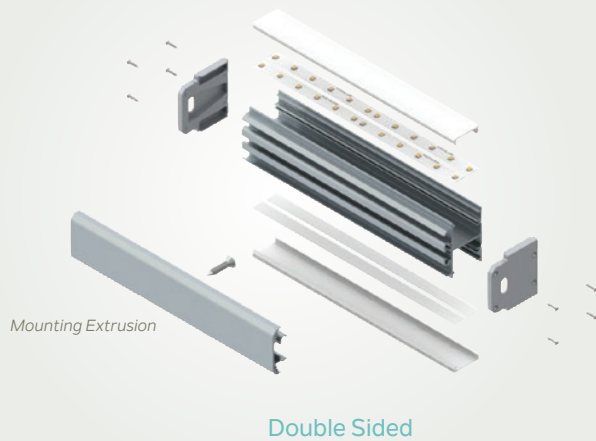
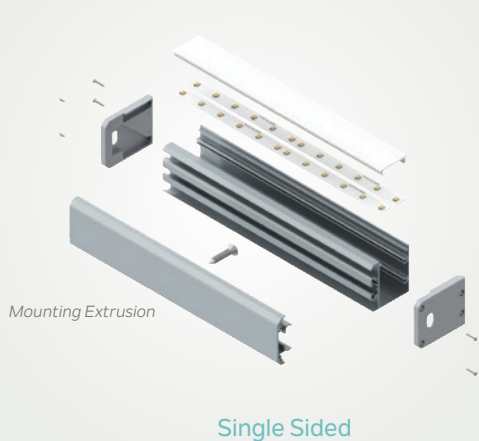

		Sconces				
		Sconce – Single Sided	Sconce – Double Sided			
Channel						
Installation View						
Tape Capacity		• Utilizes two strips of LED tape	• Utilizes two strips of LED tape on each side			
Description		• One-sided channel designed to create an up, down, left or right wall mounted sconce, bath bar or pendant light.	• Two-sided channel designed to create an up and down or left and right wall mounted sconce, bath bar or pendant light.			
		Ideal for: • Wall wash lighting, either installed horizontally or vertically. • Contemporary bath bar. • Custom-length sconce.				
Dimensions						
A La Carte To Build A Channel						
With the TE Pro Series, you build your own channel system. Tape Light Sold Separately.		Channel	Lens	End Caps	Mounting Extrusion	Accessories
Channels 8ft		1TEC2S1SF8SIL		1TEC4S2SF8SIL		
Lenses 8ft		1TEL0028WHO 2-Tape Wide Flat Lens, White Opaque <i>(Note: 1TEC4S2SF8SIL requires 2 lenses)</i>				
End Caps 2 total		1TEE2S1SFSSIL Metal with Wiring Hole		1TEE4S2SFSSIL Metal with Wiring Hole		
Mounting Extrusion 8 ft		1TEMME2SF8SIL Sconce Channel Mounting Extrusion				
Accessories		1TEA090VCONN 90° Vertical Connector Bracket 1TEA090HCONN 90° Horizontal Connector Bracket 1TEA120HCONN 120° Horizontal Connector Bracket 1TEA180HCONN Straight Connector Bracket 1TEASPKSUSSIL Pendant Suspension Cable				



EXPLODED VIEW

TE Pro Series – Corridors

Bring pathway illumination to rooms, hallways and corridors with this collection of recessed channels. Choose from a thin directional lighting effect or a broader reflective glow to create a desired end effect along the lower edge of a wall. Or, trim in smaller increments to create custom Step & Hall fixtures. Simply apply drywall mud over the flange to the trim for a clean, secure installation.

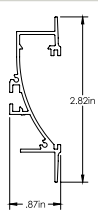
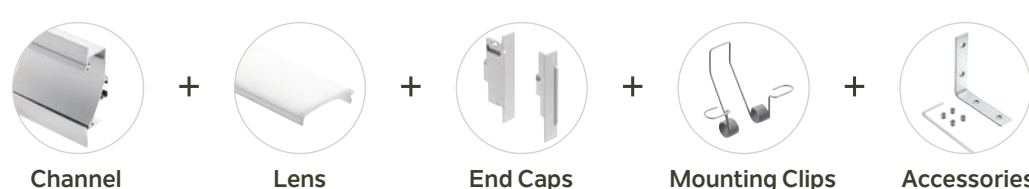
Corridors		
	Corridor – Broad/Transitional	Corridor – Thin/Contemporary
Channel	 <p style="text-align: center;">Installation View</p>	 <p style="text-align: center;">Installation View</p>
Tape Capacity	<ul style="list-style-type: none"> Utilizes one strip of LED tape 	
Description	<ul style="list-style-type: none"> Tape rests toward the top of the channel, shining down on a curved surface to create a broad, dispersed glow of light from the wall at floor level. <p> Ideal for: • Creating a broad glow of light for indoor walkways, hallways, and corridors. • Installing longer lengths as a baseboard, or trimming to creating custom Step & Hall fixtures. • Creating a fully diffused effect by utilizing the corridor lens; wall wash effect can be established without lens. </p>	<ul style="list-style-type: none"> Tape and lens rest toward the top of this baseboard trim channel, shining down into a square cavity to create a thin, indirectly diffused display of light. <p> Ideal for: • Creating a laser thin strip of light along a baseboard. • Wayfinding in corridors • Creating custom step/hall fixtures. </p>
	Dimensions	
A La Carte To Build A Channel With the TE Pro Series, you build your own channel system. Tape Light Sold Separately.	 <p style="text-align: center;"> Channel Lens End Caps Mounting Clips Accessories </p>	
Channels 8ft	1TEC1C1RC8SIL	1TEC1C2RC8SIL
Lenses 8ft	1TEL0018WHO Flat White Opaque 1TEL0018CLR Flat Clear	
	1TELC008WHO Corridor Lens, White Opaque	–
End Caps 2 total	1TEE1C1RCSSIL Metal with Wiring Hole	1TEE1C2RCSSIL Metal with Wiring Hole
Mounting Clips 10 Total	1TEMSC1RC Spring Clip	
Accessories	1TEA090VCONN 90° Vertical Connector Bracket	
	1TEA090HCONN 90° Horizontal Connector Bracket	
	1TEA120HCONN 120° Horizontal Connector Bracket	
	1TEA180HCONN 180° Horizontal Connector Bracket	

Compatible with Kichler Standard Output (1.5W/ft) and High Output (3W/ft) LED Tape Light.

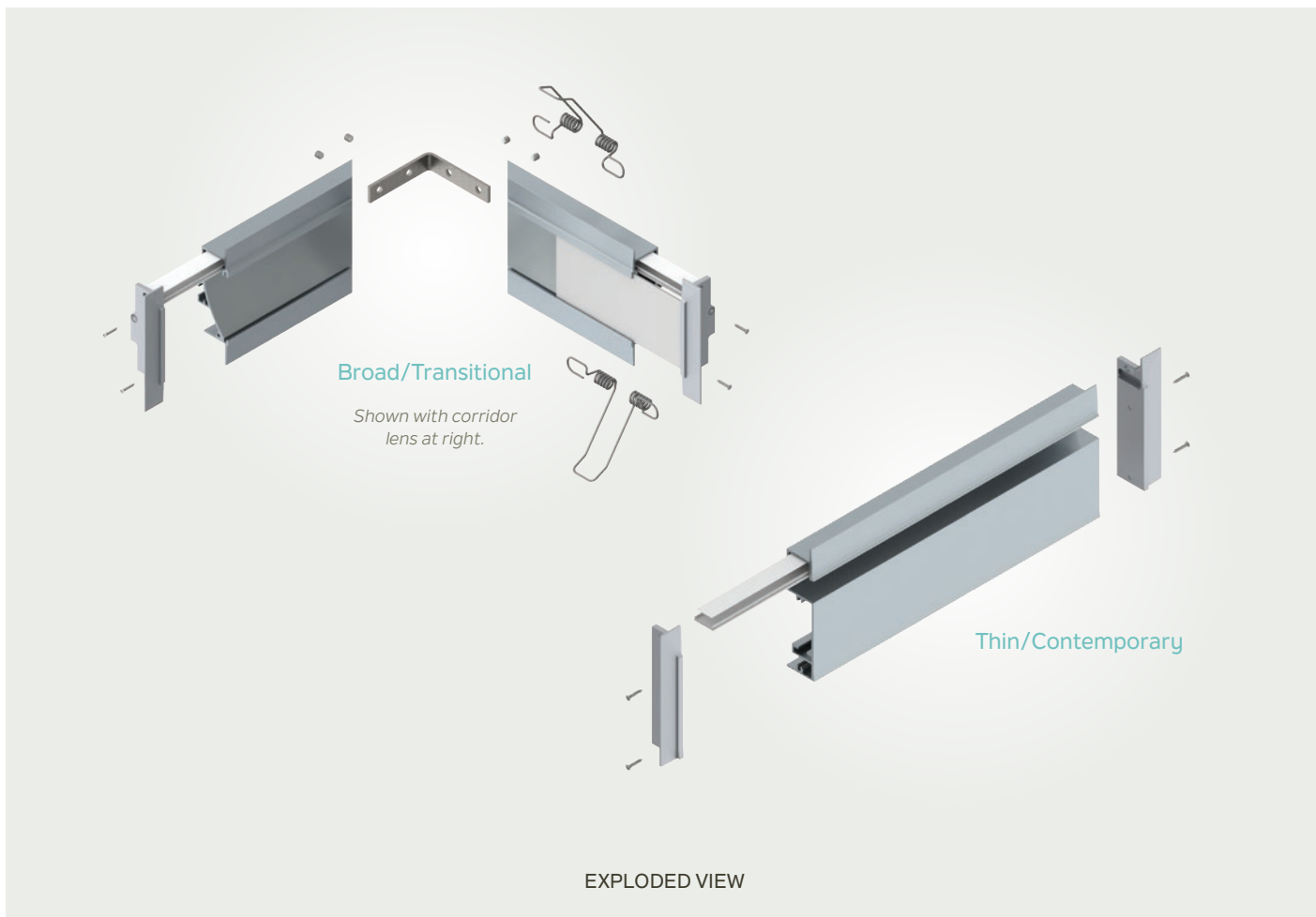

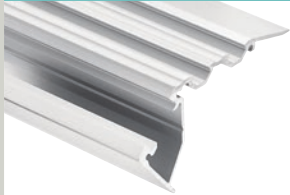
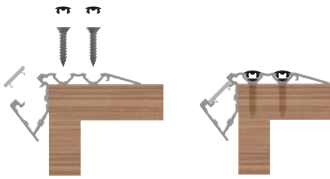
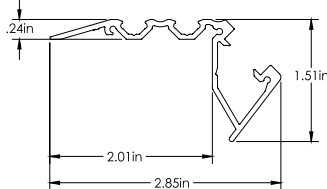

TE Pro Series – Tread & Floor

Incorporate light into a flooring design with this collection of channels. Line stair treads in theaters, auditoriums, or stairwells with the tread channel. Recess a length of light into wood or tile flooring throughout a home, hotel or retail space. Beyond creating a unique aesthetic, the channels and lens offer durable design features for floor wear and tear.

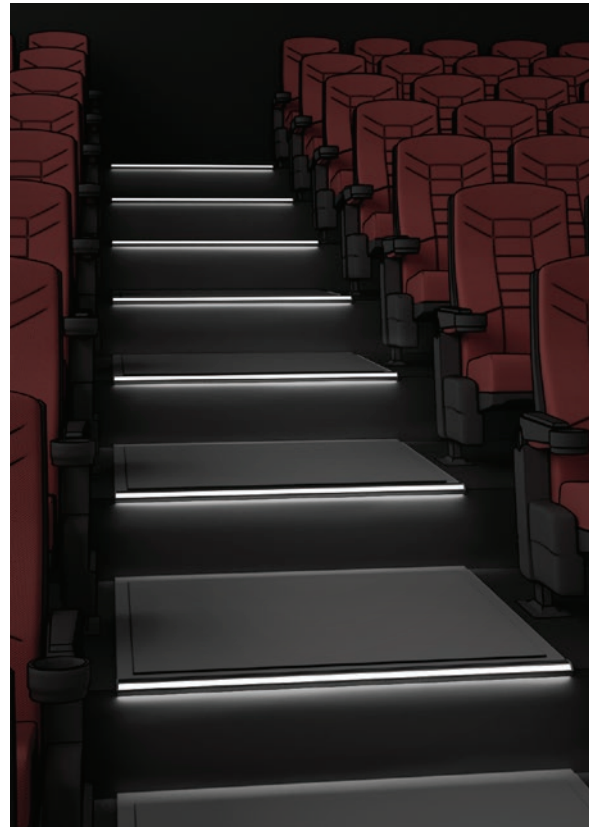
Tread	
Channel	
Installation View	
Tape Capacity	<ul style="list-style-type: none"> Utilizes up to four strips of LED tape – 1 that's downward facing; 3 that direct light up/out.
Description	<ul style="list-style-type: none"> Surface mount step tread channel that wraps over and down the edge of a step. The channel design offers both upward and downward facing light. The durable PVC lens is IK07 impact rated for floor wear and tear and features an IP54 rated co-molded silicon edge to combat some water ingress, but not full immersion or standing water. <p>Ideal for:</p> <ul style="list-style-type: none"> Step tread lighting, in applications like movie theaters, basements, contemporary apartments and auditoriums.
Dimensions	
A La Carte To Build A Channel With the TE Pro Series, you build your own channel system. Tape Light Sold Separately.	Channel + Lens + End Caps + Accessories
Channels 8ft	1TEC4TRSF8SIL
Lenses 8ft	1TEFL18WHO PVC Lens, White Opaque
End Caps 2 total	1TEE4TRSFSSIL Metal with Wiring Hole
Accessories	1TEA4TRSF8BK Non-slip insert (Anti-slip tread rope) See Page 66 for more details

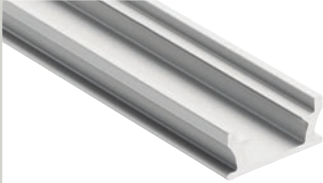

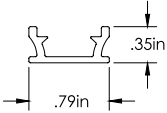
	Floor
Channel	
Installation View	
Tape Capacity	• Utilizes one strip of LED tape
Description	<ul style="list-style-type: none"> • Decorative, recessed floor accent features slightly angled sides to allow floor glue or grout in, securely adhering the channel within the flooring. The durable PVC lens is IK07 impact rated for floor wear and tear and features an IP54 rated co-molded silicon edge to combat some water ingress, but not full immersion or standing water. <p>Ideal for:</p> <ul style="list-style-type: none"> • Decorative in-floor lighting for up-scale contemporary housing, hotels, retail centers and offices.
Dimensions	
A La Carte To Build A Channel With the TE Pro Series, you build your own channel system. Tape Light Sold Separately.	Channel + Lens + End Caps + Accessories
Channels 8ft	1TEC1FLRC8SIL
Lenses 8ft	1TEFL18WHO PVC Lens, White Opaque
End Caps 2 total	1TEE1FLRCSSIL Metal with Wiring Hole



TE Enhanced Series – Overview

The Kichler® TE Enhanced Series of aluminum extruded tape channels is a step up from a simple lighting effect. The 30-degree angled channel doubles as a 60-degree channel when rotated for expanded installation options. The surface and recessed channels in this series are wide enough to accommodate multiple strips of LED tape light. The added illumination takes your tape light installation from accent to ambient: ideal for task-driven applications.

Surface Mount

These channels install onto a surface to create sturdy under-cabinet, shelving or even step lighting. Miter cut and connect for custom shapes.

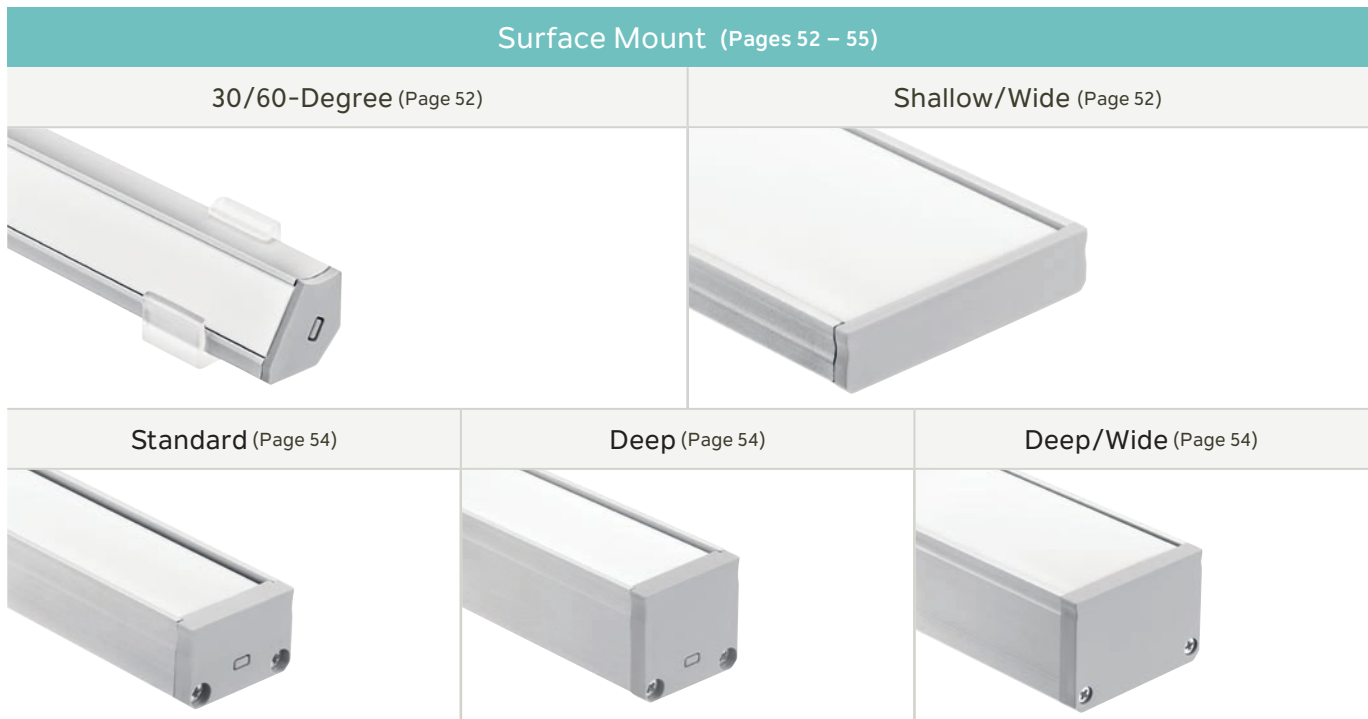





Recessed Mount

By creating space within drywall, shelving or other surfaces, recessed channels can then be inset for a seamless, built-in lighting effect. Miter cut and connect for custom shapes.





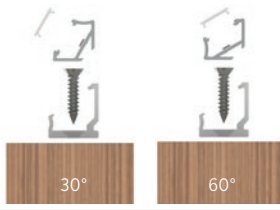
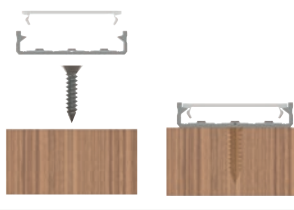
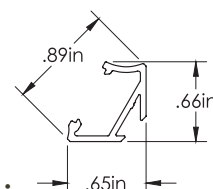
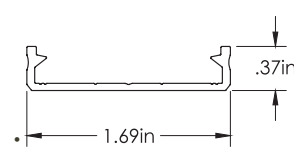





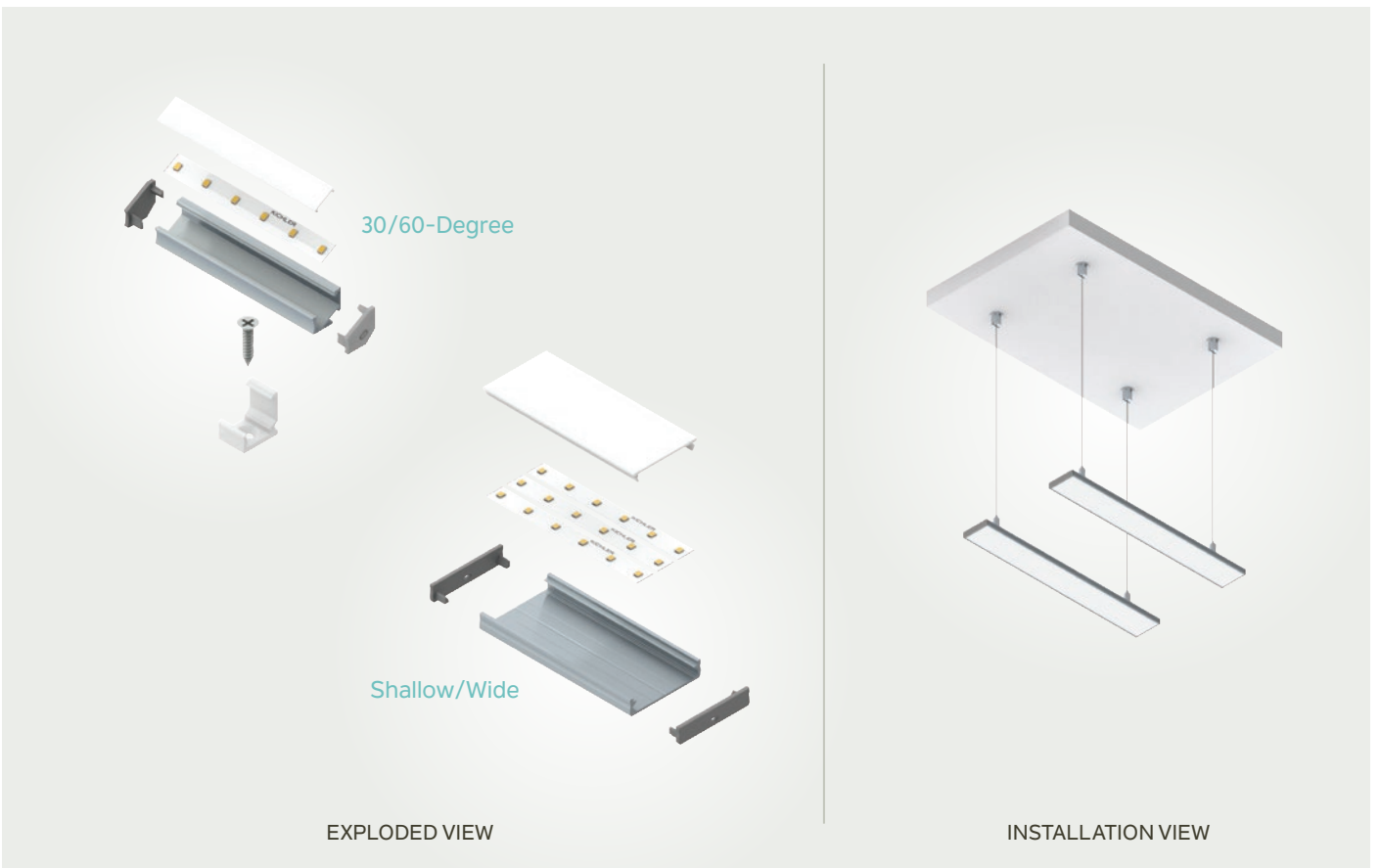





TE Enhanced Series – Surface Mount

	Surface Mount	
	30/60-Degree	Shallow/Wide
Channel		
Installation View		
Tape Capacity	<ul style="list-style-type: none"> Utilizes one strip of LED tape 	<ul style="list-style-type: none"> Utilizes three strips of LED tape
Description	<ul style="list-style-type: none"> Asymmetrical design allows for a 30- or 60-degree installation <p>Ideal for:</p> <ul style="list-style-type: none"> Under cabinets Under steps Drawers 	<ul style="list-style-type: none"> Flat surface installation <p>Ideal for:</p> <ul style="list-style-type: none"> Custom pendants Task-driven under cabinet applications like laundry or craft areas. Home offices
Dimensions		
A La Carte To Build A Channel With the TE Enhanced Series, you build your own channel system. Tape Light Sold Separately.	 <p>Channel + Lens + End Caps + Mounting Clips + Accessories</p>	
Channels 8ft	1TEC130SF8SIL	1TEC3SWSF8SIL
Lenses 8ft	1TEL0018WHO Flat White Opaque 1TEL0018CLR Flat Clear 1TEL1518 CLR Narrow Beam Lens, Clear 1TEL3018CLR Medium Beam Lens, Clear	1TEL0038WHO 3-Tape Wide Flat Lens, White Opaque
End Caps 10 total	1TEE130SFSSIL 5 Pairs [left/right] Each with Knockout for Wires	1TEE3SWSFSSIL 5 with Wiring Hole, 5 without
Mounting Clips 10 total	1TEM130SFCLR	–
Accessories	1TEASPKSUSSIL Pendant Cable	

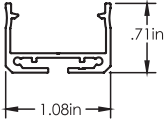
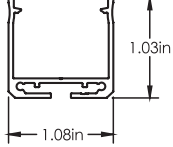
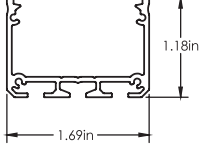
Compatible with Kichler Standard Output (1.5W/ft) and High Output (3W/ft) LED Tape Light.

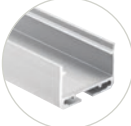

TE Enhanced Series – Surface Mount

Surface Mount			
	Standard	Deep	Deep/Wide
Channel			
Installation View			
Tape Capacity	• Utilizes two strips of LED Tape		• Utilizes three strips of LED tape
Description	<ul style="list-style-type: none"> • Flat surface installation Ideal for task-driven lighting: <ul style="list-style-type: none"> • Wood beam accent • Under cabinets • Shelves • Pendants • Miter cut and connect with 1TEA Connector accessories for custom shapes (<i>See below</i>) 		
Dimensions			
A La Carte To Build A Channel With the TE Enhanced Series, you build your own channel system. Tape Light Sold Separately.	 <div style="display: flex; justify-content: space-around; text-align: center;"> <div> Channel</div> <div>+</div> <div> Lens</div> <div>+</div> <div> End Caps</div> <div>+</div> <div> Accessories</div> </div>		
Channels 8ft	1TEC2STSF8SIL	1TEC2DWSF8SIL	1TEC3DWSF8SIL
Lenses 8ft	1TEL0028WHO 2-Tape Wide Flat Lens, White Opaque		1TEL0038WHO 3-Tape Wide Flat Lens, White Opaque
End Caps 10 total	1TEE2STSFSSIL All with Knockout for Wires	1TEE2DWSFSSIL All with Knockout for Wires	1TEE3DWSFSSIL 5 with Wiring Hole, 5 without
Accessories 1 each (connectors include hex screws and hex key)	1TEA180HCONN Straight Connector Bracket 1TEA090VCONN 90° Vertical Connector Bracket 1TEA090HCONN 90° Horizontal Connector Bracket 1TEA120HCONN 120° Horizontal Connector Bracket 1TEASPKSUSSIL Pendant Cable		

Compatible with Kichler Standard Output (1.5W/ft) and High Output (3W/ft) LED Tape Light.

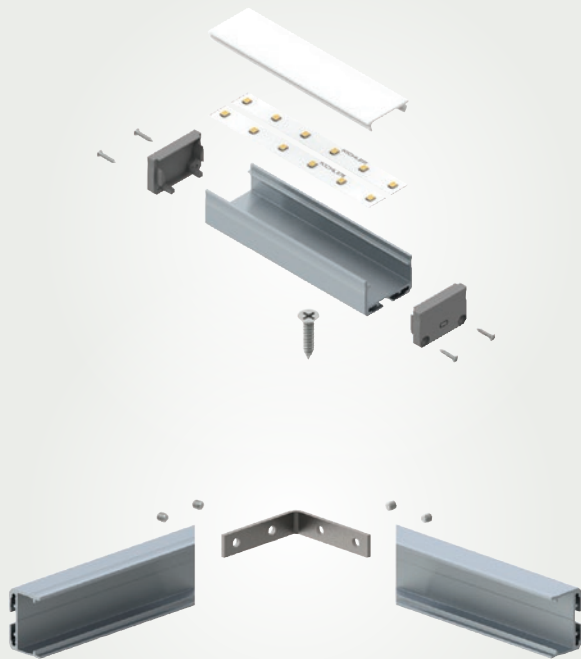







EXPLODED VIEW

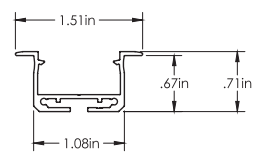
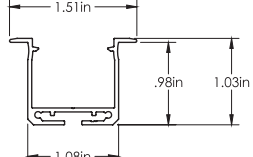
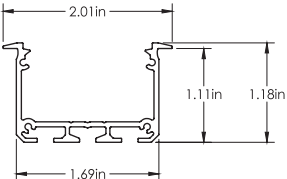

INSTALLATION VIEW

TE Enhanced Series – Recessed Mount

Recessed Mount			
	Standard	Deep	Deep/Wide
Channel			
Installation View			
Tape Capacity	• Utilizes two strips of LED tape		• Utilizes three strips of LED tape
Description	<p>• Flat recessed installation (requires fabricating a recess to mount flush with surface)</p> <p>Ideal for:</p> <ul style="list-style-type: none"> • Recessed under cabinets • Recessed into shelving, or under an island • Recessed wall, ceiling or niche accent • Miter cut and connect with 1TEA Connector accessories for custom shapes (<i>See below</i>) 		
Dimensions			
A La Carte To Build A Channel With the TE Enhanced Series, you build your own channel system. Tape Light Sold Separately.			
Channels 8ft	1TEC2STRC8SIL	1TEC2DWRC8SIL	1TEC3DWRC8SIL
Lenses 8ft	1TEL0028WHO 2-Tape Wide Flat Lens, White Opaque		1TEL0038WHO 3-Tape Wide Flat Lens, White Opaque
End Caps 10 total	1TEE2STRCSSIL All with Holes for Wires	1TEE2DWRCSSIL All with Holes for Wires	1TEE3DWRCSSIL All without Holes – Use T-Slot for Wire Exit
Mounting Clips 10 total	1TEMSC1RC Spring Clip		
Accessories	1TEA180HCONN Straight Connector Bracket 1TEA090VCONN 90° Vertical Connector Bracket 1TEA090HCONN 90° Horizontal Connector Bracket 1TEA120HCONN 120° Horizontal Connector Bracket		

Compatible with Kichler Standard Output (1.5W/ft) and High Output (3W/ft) LED Tape Light.

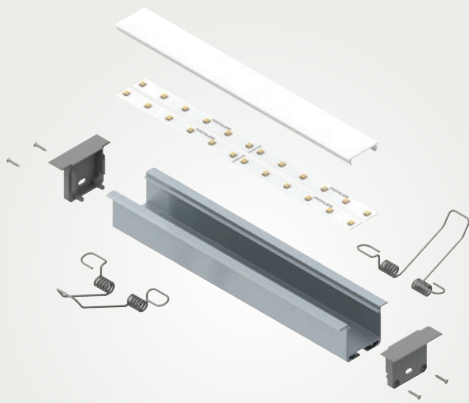

EXPLODED VIEW

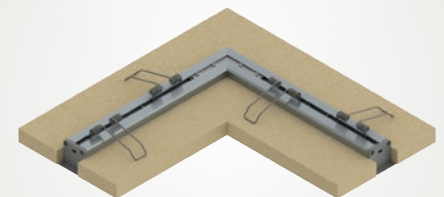
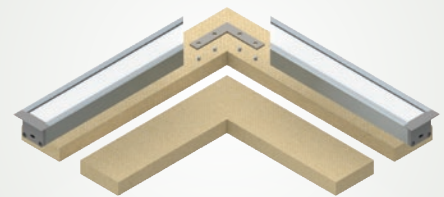

INSTALLATION VIEW

TE Standard Series – Overview

The Kichler TE Standard Series of aluminum extruded tape channels elevates your kitchen and shelving projects. With simple mounting clips, varying depths for desired light diffusion and snap-in lenses, these channels offer a polished look while simplifying the installation process. The TE Standard Series is available a la carte or in kit form for ease in ordering.

Surface Mount Kits (Page 60)









Recessed Mount Kits (Page 62)



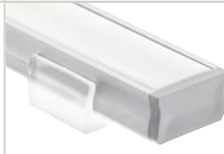
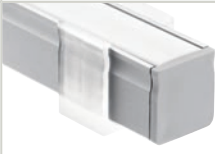
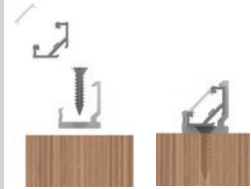
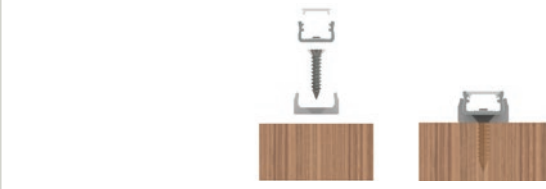
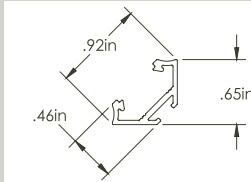
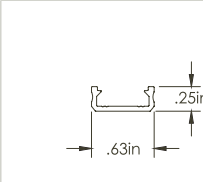
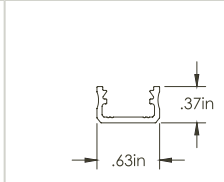
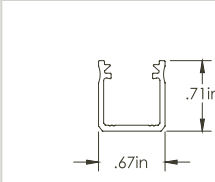
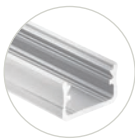

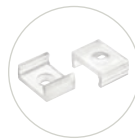
TE Standard Series – Surface Mount

	Surface Mount			
Kits	45-Degree	Shallow	Standard	Deep
Full Kit				
Installation View				
Tape Capacity	• Utilizes one strip of LED tape			
Description	• Surface mount			
	• 45° channel	• Sleek, cost effective, visible diodes	• Common depth offers gently diffused diodes	• Ideal depth for a spot-free lighting effect
	Ideal for: • Under cabinets • Under steps • Drawers	Ideal for: • Under cabinets • Above cabinets or along toe kicks • Shelves		
Dimensions				
Kit Models	45-Degree: 1TEK145SF2SIL – 2' 1TEK145SF4SIL – 4' 1TEK145SF8SIL – 8' Tape Light Sold Separately.	Shallow: 1TEK1SWSF2SIL – 2' 1TEK1SWSF4SIL – 4' 1TEK1SWSF8SIL – 8'	Standard: 1TEK1STSF2SIL – 2' 1TEK1STSF4SIL – 4' 1TEK1STSF8SIL – 8'	Deep: 1TEK1DWSF2SIL – 2' 1TEK1DWSF4SIL – 4' 1TEK1DWSF8SIL – 8'
A La Carte	 +  +  +  + 			
To Build A Channel	The TE Standard Series also offers the option to build your own channel system. Tape Light Sold Separately.			
Channels 8ft	1TEC145SF8SIL	1TEC1SWSF8SIL	1TEC1STSF8SIL	1TEC1DWSF8SIL
Lenses 8ft	1TEL0018WHO Flat White Opaque		1TEL0018CLR Flat Clear	
	1TEL1518CLR Narrow Beam Lens, Clear		1TEL3018CLR Medium Beam Lens, Clear	
	–	1TELH018WHO High Diffusion, White Opaque		–
End Caps	1TEE145SFSSIL	1TEE1SWSFSSIL	1TEE1STSFSSIL	1TEE1DWSFSSIL
10 total: 5 with Wiring Hole, 5 without		1TEE1SWSFHSSIL Pairs with High Diffusion Lens	1TEE1STSFHSSIL Pairs with High Diffusion Lens	
Mounting Clips 10 total	1TEM145SFCLR	1TEM1SWSFMCLR	1TEM1STSFMCLR	1TEM1DWSFCLR
Accessories	1TEASPKSUSSIL Pendant Cable			
	–	–	–	1TEA1DWADJ8SIL Beam Spread Adjustment (See pages 65 – 66)



45-Degree







Standard

EXPLODED VIEW

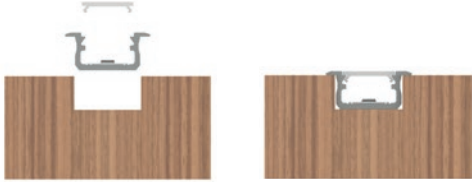
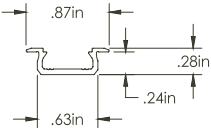
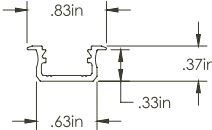
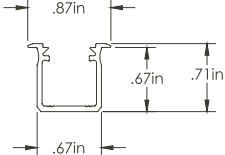
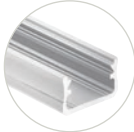

INSTALLATION VIEW

TE Standard Series – Recessed Mount

Recessed Mount			
Kits	Shallow	Standard	Deep
Full Kit			
Installation View			
Tape Capacity	• Utilizes one strip of LED Tape		
Description	<ul style="list-style-type: none"> • Recessed installation (requires routing into wood or drywall) • Ideal for: <ul style="list-style-type: none"> • Recessed under cabinets • Recessed into shelving or under a kitchen island • Wall or niche accent 		
Dimensions			
Kit Models	<p>Include: Channel, Lens (White Opaque), End Caps (2) and Mounting Clips (3, 5 or 9 for 2', 4' and 8' Kits respectively). Tape Light Sold Separately.</p> <p>Shallow: 1TEK1SWRC2SIL – 2' 1TEK1SWRC4SIL – 4' 1TEK1SWRC8SIL – 8'</p>	<p>Standard: 1TEK1STRC2SIL – 2' 1TEK1STRC4SIL – 4' 1TEK1STRC8SIL – 8'</p>	<p>Deep: 1TEK1DWRC2SIL – 2' 1TEK1DWRC4SIL – 4' 1TEK1DWRC8SIL – 8'</p>
A La Carte	<p>To Build A Channel</p> <p>TE Standard Series Recessed channels also offer the option to build your own channel system. Tape Light Sold Separately.</p> <div style="display: flex; justify-content: space-around; align-items: center;"> <div style="text-align: center;">  Channel </div> <div style="text-align: center;">+</div> <div style="text-align: center;">  Lens </div> <div style="text-align: center;">+</div> <div style="text-align: center;">  End Caps </div> </div>		
Channels 8ft	1TEC1SWRC8SIL	1TEC1STRC8SIL	1TEC1DWRC8SIL
Lenses 8ft	1TEL0018WHO Flat White Opaque 1TEL0018CLR Flat Clear 1TEL1518CLR Narrow Beam Lens, Clear 1TEL3018CLR Medium Beam Lens, Clear		
End Caps 10—all with Wiring Hole	1TEE1SWRCSSIL	1TEE1STRCSSIL	1TEE1DWRCSSIL

Compatible with Kichler Standard Output (1.5W/ft) and High Output (3W/ft) LED Tape Light.

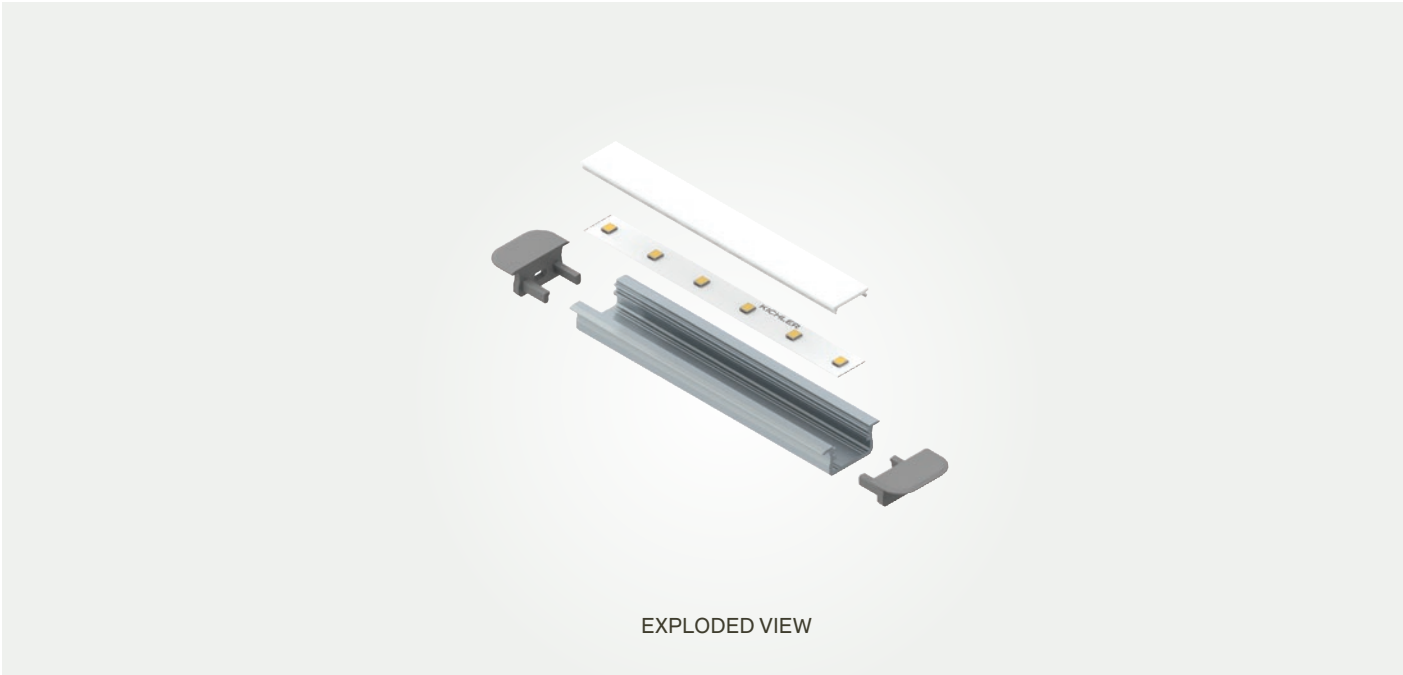

Channel Depth & Lenses

Channel Depth

- **Shallow Channel** - sleek, cost effective, presents a light distribution that's true to its source
- **Standard Channel** - common depth offers a light distribution that is gently diffused
- **Deep Channel** - allows the light to blend within the channel, resulting in a greater diffused light

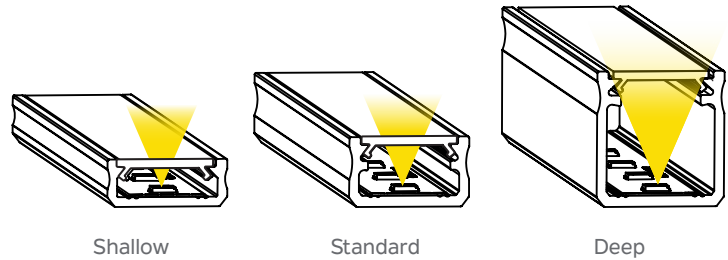

Lenses

- **Clear Lens** - allows the most light through, noting that diodes will be more visible
- **White Opaque Lens** - diffuses the diodes more, as well as disperses the light output
- **Narrow and Medium Lenses** - utilized to create a thinner, more direct beam for a desired end effect.
- **High Diffusion Lens** - sits up higher, creating more of a beam angle. The added height of the lens also works to disperse more light. This lens works with Shallow and Standard surface mount channels.
- **PVC Lens** - designed specifically for the Pro Series Step Tread and In-Floor Channels. The durable material can also withstand impact and features a co-molded silicone edge – IP54 rated to combat some water, but not fully submerge.



TAPE SOLD SEPARATELY.

Standard and High Output tape products are the best complement for the TE Series channels. To view our 24V (8T and 6T) and 12V (4T) tape like products, see pages 14 – 18.



Beam Spread Adjustment Accessory

Combine the Deep Well Surface Mount Channel (1TEC1DWSF8SIL) with the Beam Spread Adjustment Accessory (1TEA1DWADJ8SIL) and pair with either a flat, narrow or medium clear lens (1TEL-00/15/30-18CLR) to create one of nine custom beam spread options.

The Beam Spread Adjustment Accessory can be inserted at the base of the channel, or inverted to elevate the LED placement to two different heights. The illustrations below depict the deep well channel without the adjustment accessory, as well as the effect achieved once inserted.

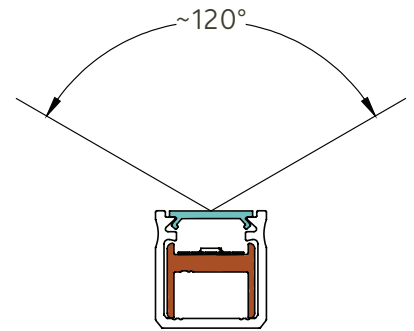
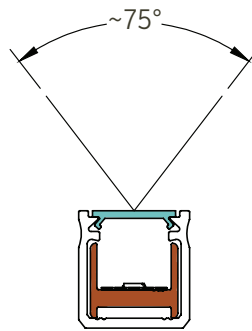
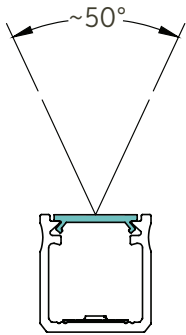

Shown with flat lens

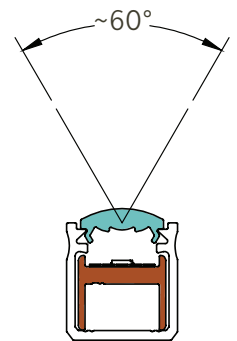
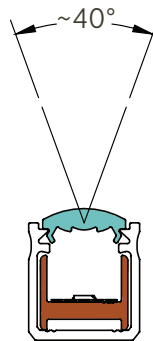
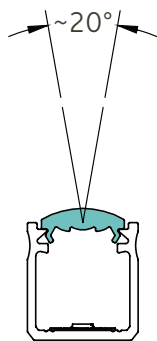



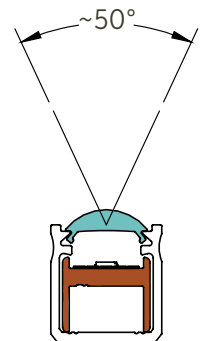
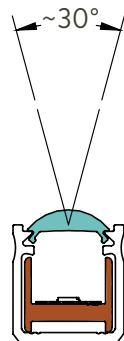
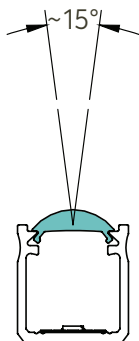



Shown with medium lens



Shown with narrow lens



Channel Accessories

 <p>1TEA090HCONN 90-degree connector bracket</p>	 <p>1TEA180HCONN Straight connector bracket</p>	 <p>1TEA090VCONN 90-degree vertical connector bracket</p>	 <p>1TEA120HCONN 120-degree connector bracket</p>	 <p>1TEMSC1RC Spring mounting clip</p>	 <p>1TEASPKSUSSIL Pendant cable</p>
<p>Utilize brackets to extend the length of your channel design, or to connect mitered ends to create custom corners.</p>				<p>For recessed installations with designated channels.</p>	<p>To suspend channels as a fixture.</p>

Pro - Rod Mounting Collars

 <p>1TEA1RDSFBCCH Rod wall-mount collar accessory</p>	 <p>1TEA1RDSFHCCCH Rod high collar – closed-end hanging accessory</p>	 <p>1TEA1RDSFHCOCH Rod high collar – open-end hanging accessory</p>	 <p>1TEA1RDSFLCCCH Rod low collar – closed-end hanging accessory</p>	 <p>1TEA1RDSFLCOCH Rod low collar – open-end hanging accessory</p>
<p>Utilize these mounting collars to affix the rod channel to a wall, or suspended from above. The open-end collars allow the rod to run through and should be set every 12" to offer support to the rod. The closed-end collars would then be used on the end of the rod. High collars measure 3" overall height and Low collars measure 2¼" overall height.</p>				

Pro - Rod Beam Adjustment

 <p>1TEA1RDSFBAESIL Rod beam adjustment end cap accessory</p>	 <p>1TEA1RDADJ8SIL Rod beam adjustment insert</p>
<p>These beam adjustment accessories for the Rod channel allow you to adjust placement and direction of the tape within the channel.</p>	

Pro - Tread Insert

 <p>1TEA4TRSF8BK Pro – Floor Non-Slip Insert</p>
<p>Utilize these durable tread channel inserts for additional traction.</p>

Tracks & End Caps

Broaden your installation options with track and diffusers that allow you to customize the direction and appearance of your tape light.

Tracks and End Caps				
			Compatible Fixtures	
90° Aluminum Track*	10171 BK, WH – 12" 10-pack	0.5" W x 0.5625" H Includes 11 End Caps Pre-installed screws every 6"	4TL Series 12V 6TL Series 24V Dry 6TL Series 24V Damp 6TL Series 24V RGB	
	10170 BK, WH – 36" 10-pack			
90° End Caps	10177 BK, WH 5-pack		10171 BK, WH 10170 BK, WH	
45° Aluminum Track*	10173 BK, WH – 12" 10-pack	0.5" W x 0.5" H Includes 11 End Caps Pre-installed screws every 6"	4TL Series 12V 6TL Series 24V Dry 6TL Series 24V Damp 6TL Series 24V RGB	
	10172 BK, WH – 36" 10-pack			
45° End Caps	10178 BK, WH 5-pack		10173 BK, WH 10172 BK, WH	
U-Channel Aluminum Track*	10175 BK, WH – 12" 10-pack	0.5" W x 0.75" H Includes 11 End Caps Pre-installed screws every 6"	4TL Series 12V 6TL Series 24V Dry 6TL Series 24V Damp 6TL Series 24V RGB	
	10174 BK, WH – 36" 10-pack			
U-Channel End Caps	10176 BK, WH 5-pack		10175 BK, WH 10174 BK, WH	
Diffuser	10179 – 36" Cut to size		10175 BK, WH 10174 BK, WH	
Plastic Track	12330 BK, WH – 36" 10-pack Pre-installed screws every 6" Snaps on the score every 6"		4TL Series 12V 6TL Series 24V Dry (except ultra-high) 6TL Series 24V Damp 6TL Series 24V RGB	

*Recommended for ultra-high output tape installations



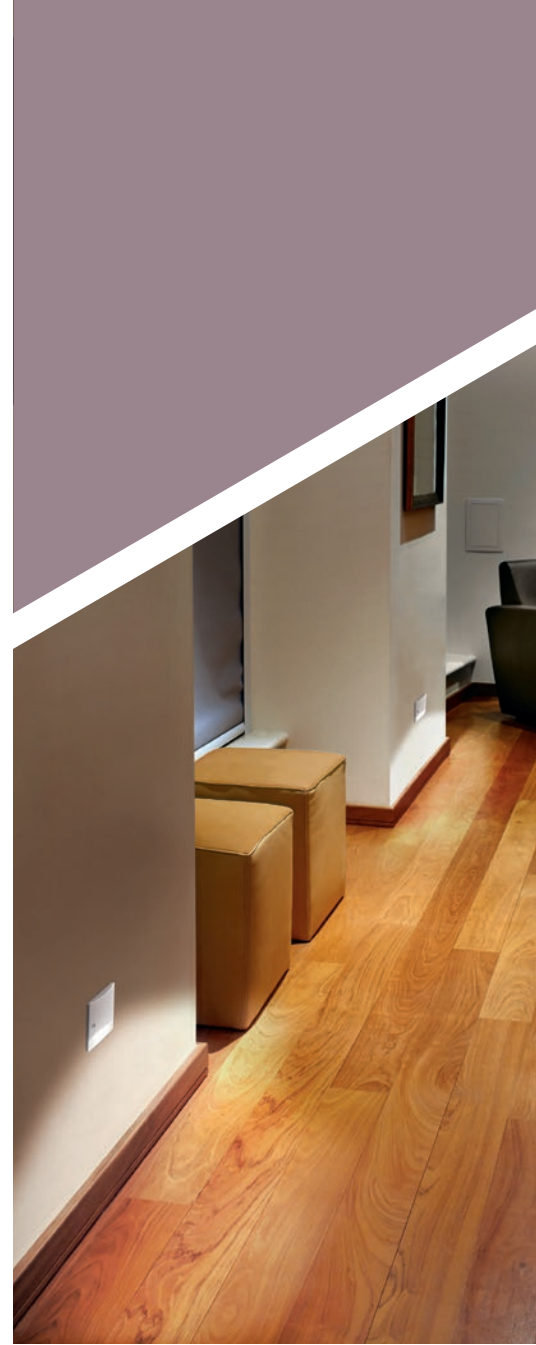

LED Step & Hall Lighting

A subtle solution to light the way.

Midnight trips up the stairs, down corridors, or even through the kitchen at night; with step and hall lighting, you can illuminate commonly traveled areas without turning on harsh overhead light. The soft glow of LED adds safety, security and essential evening illumination.



Step & Hall 120V LED

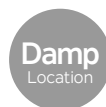

Engineered for simplicity.

Every light engine is engineered specifically for its matching faceplate to achieve optimal light quality and greater efficiency. The product is easy to install, thanks to captive mounting screws and push-in wire connectors that can accommodate daisy chain wiring for added simplicity.

AVAILABLE FACEPLATE DESIGNS



- 12672** ALM, AZ, NI, WH
• Shown in Almond (ALM)
• 4.875" W x 3.125" H
• Dimmable
• Screwless faceplate
• 1 Watt



- 12662** ALM, AZ, NI, WH
• Shown in Almond (ALM)
• 4.875" W x 3.125" H
• 1 Watt



- 12673** ALM, AZ, NI, WH
• Shown in Architectural Bronze (AZ)
• 4.875" W x 3.125" H
• Dimmable
• Screwless faceplate
• 1 Watt



- 12663** ALM, AZ, NI, WH
• Shown in Architectural Bronze (AZ)
• 4.875" W x 3.125" H
• 1 Watt



- 12674** ALM, AZ, NI, WH
• Shown in Brushed Nickel (NI)
• 4.875" W x 3.125" H
• Dimmable
• Screwless faceplate
• 1 Watt



- 12664** ALM, AZ, NI, WH
• Shown in Brushed Nickel (NI)
• 4.875" W x 3.125" H
• 1 Watt



- 12675** ALM, AZ, NI, WH
• Shown in White (WH)
• 4.875" W x 3.125" H
• Dimmable
• Screwless faceplate
• 1 Watt



- 12665** ALM, AZ, NI, WH
• Shown in White (WH)
• 4.875" W x 3.125" H
• 1 Watt



- 12600** AZ, WH
• Shown in Architectural Bronze (AZ)
• 4.5" W x 2.75" H
• 1.5 Watt



- 12602** AZ, WH
• Shown in White (WH)
• 4.5" W x 2.75" H
• 1 Watt

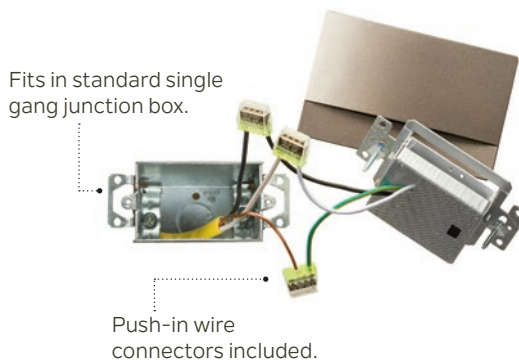



- 12676** ALM, AZ, NI, WH
 • Shown in Almond (ALM)
 • 3.125" W x 4.875" H
 • Dimmable
 • Screwless faceplate
 • 1 Watt



- 12666** ALM, AZ, NI, WH
 • Shown in Almond (ALM)
 • 3.125" W x 4.875" H
 • 1 Watt



- 12677** ALM, AZ, NI, WH
 • Shown in Architectural Bronze (AZ)
 • 3.125" W x 4.875" H
 • Dimmable
 • Screwless faceplate
 • 1 Watt



- 12667** ALM, AZ, NI, WH
 • Shown in Architectural Bronze (AZ)
 • 3.125" W x 4.875" H
 • 1 Watt



- 12678** ALM, AZ, NI, WH
 • Shown in Brushed Nickel (NI)
 • 3.125" W x 4.875" H
 • Dimmable
 • Screwless faceplate
 • 1 Watt



- 12668** ALM, AZ, NI, WH
 • Shown in Brushed Nickel (NI)
 • 3.125" W x 4.875" H
 • 1 Watt



- 12604** AZ, WH
 • Shown in Architectural Bronze (AZ)
 • 2.75" W x 4.5" H
 • 1 Watt



- 12606** AZ, WH
 • Shown in White (WH)
 • 2.75" W x 4.5" H
 • 1.5 Watt

Features

Installation Features

- Fast installation with push-in wire connectors and captive mounting screws
- Snap-off tabs to retrofit into any standard junction box/receptacle
- Integral 120V input driver
- Aluminum housing with die-cast aluminum faceplates
- IC rated
- ETL rated for damp locations
- ADA compliant

Light Features

- Light output: 8-30 lumens, visit Kichler.com for details
- Power consumption: 1 Watt
- Color Rendering Index (CRI): >80
- Correlated Color Temperature (CCT): 3500K +/- 150K
- Balanced lighting – free of shadows, cutoffs and striping



Hall or Wall Installation



Step Installation





Technical Resources

Tips and services to help you organize your next lighting system.

Kichler Lighting is here to support you - from complimentary pre-installation layout services to post-installation technical support. We can offer an array of advice, from power supply maximization to complete step-by-step tape installation instructions.



Power Supply Optimization

Get more from your power supply.

The diagrams below illustrate ways to break up your runs into multiples, which will ultimately result in additional inches of tape or accent lighting operating from one power supply. In addition to efficiencies gained in materials, the shorter linear runs will also help to maximize the light output potential for a beautiful end effect.

Maximize Light Output and the Power Supply

12V HIGH OUTPUT:

Max. linear run length is 16', but connecting two 10' lengths in parallel increases total run to 20' using a 60W power supply.

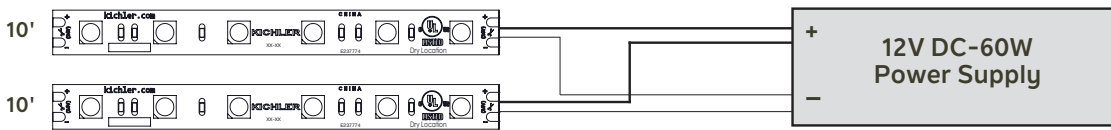

12V STANDARD OUTPUT:

Max. linear run length is 16', connecting four 10' lengths in parallel increases total run to 40' using a 60W power supply.

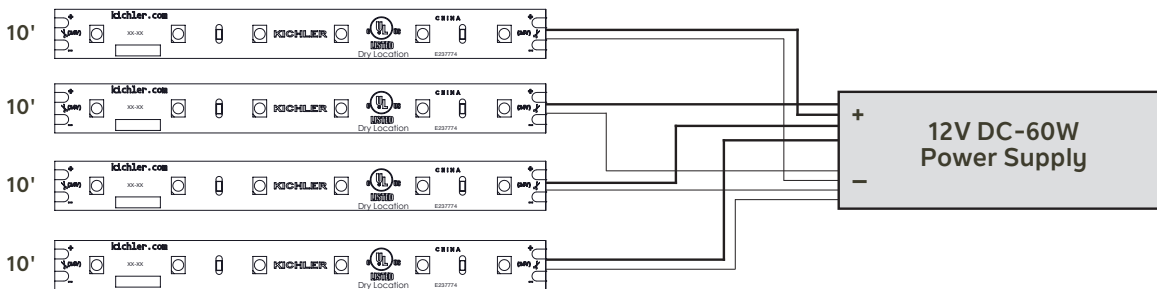

12V ACCENT DISC:

The ideal way to maximize your power supply on an accent disc installation is to combine with Kichler® 12V LED tape (4T Series).

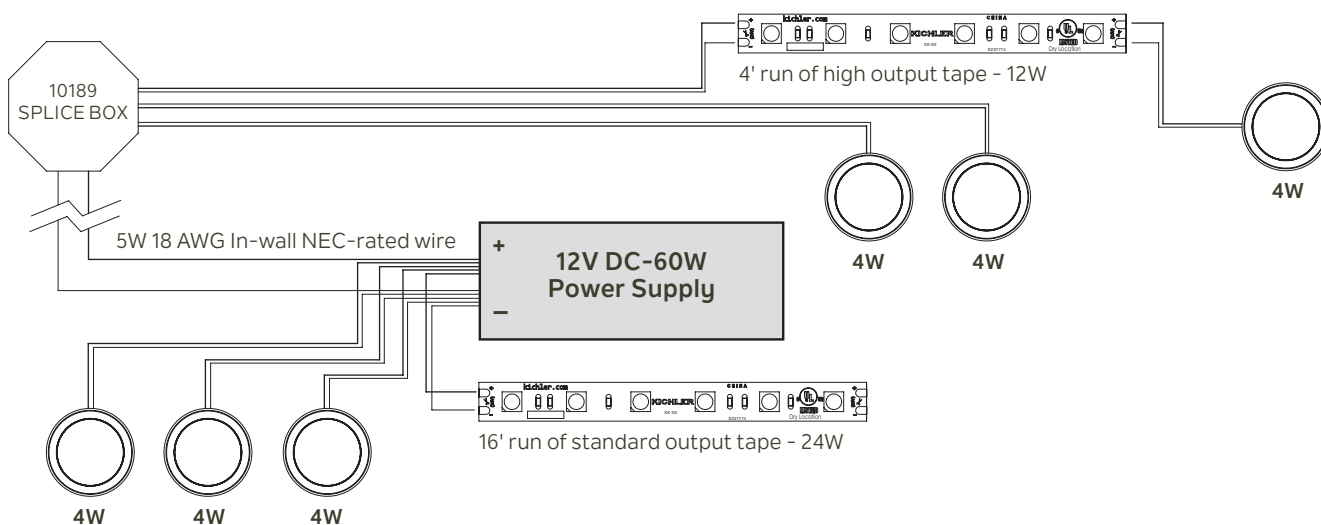

24V ULTRA-HIGH OUTPUT:

Max. linear run length is 10', but connecting two 6.5' lengths in parallel increases total run to 13' using a 96W power supply.

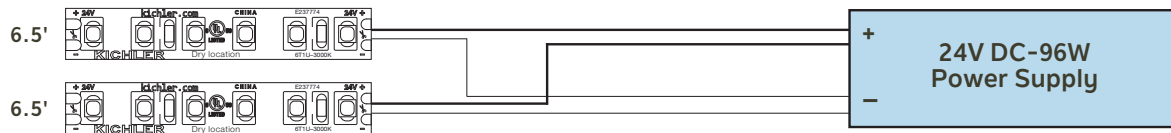

24V HIGH OUTPUT*:

Max. linear run length is 20', but connecting two 15' lengths in parallel increases total run to 30' using a 96W power supply.

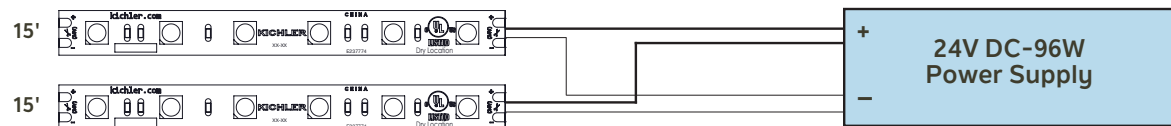

24V STANDARD OUTPUT*:

Max. linear run length is 32', but connecting two 32' or four 16' lengths in parallel increases total run to 64' using a 96W power supply.

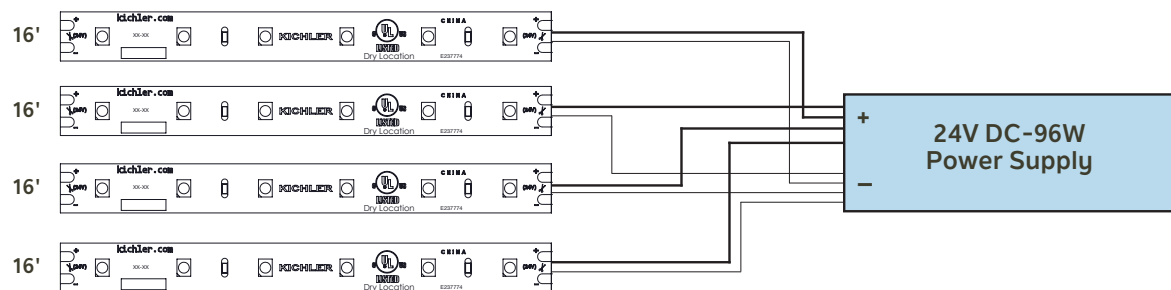

24V HARD STRIPS:

Max. linear run length is 10', but connecting three parallel runs of 8' (eight 12" lengths) of hard strips increases total run to 24' using a 96W power supply.

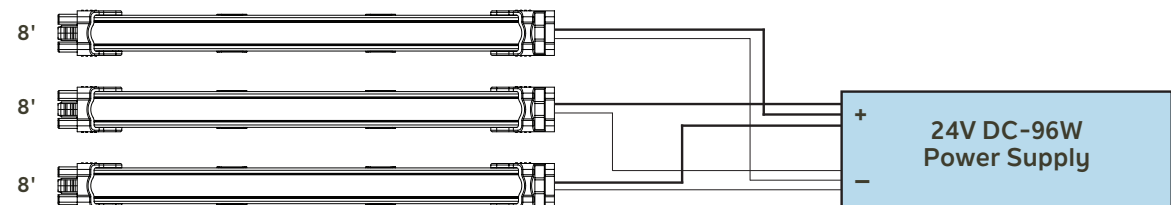

*With 8T tape you can run 33' and 67' as a single length, further reducing installation time.

Advanced Product Solutions & Layout

Free layout and design services – and so much more.

From answering questions to creating detailed layouts to delivering a full bill of materials (BOM) – the Kichler Lighting Advanced Product Solutions (APS) & Layout Team is your link to getting the job done. This FREE service takes the guesswork out of any lighting need you have: determining the scope of materials required, recommending dimmers and even creating a full wiring and product layout.

Layout Design Services

Get to a solution faster and increase sales.

From choosing landscape lighting to maximizing a kitchen's functionality; from outfitting a restaurant with lighting to coordinating lighting throughout a home – these are just a few of the jobs our Advanced Product Solutions & Layout Team can get done for you.

Contact us at layouts@Kichler.com and we'll get you started:

- 1 Email us a completed Design Request Form (available at Kichler.com/APS) along with any drawings or pictures related to the job.
- 2 We'll create a BOM and email it back to you that same day (for all requests received by 3 pm EST).
- 3 Once you confirm the BOM and pricing, we'll return a completed layout design within 48 hours or less.

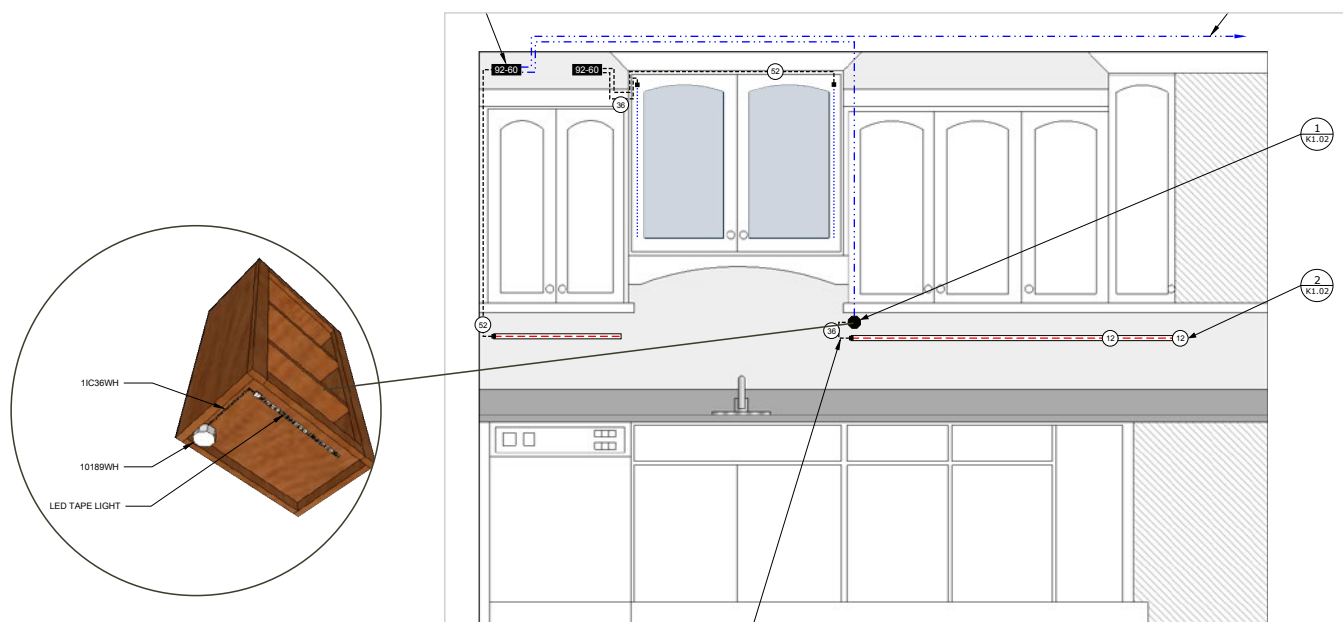

Kitchen layout using Kichler® tape light for under cabinet lighting.

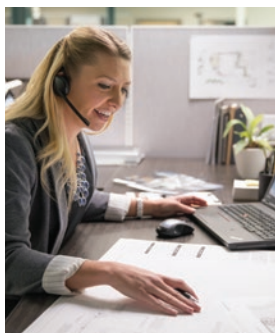

Advanced Product Support

No question is too complex.

Installation issue? Building code question? Regulatory stumper? If you think you've got a challenging question – we've got you covered. Our Advanced Product Support Team receives additional classroom and in-field training on all Kichler® products, so you can get your question answered quickly and correctly. To take advantage of this free service, call our dedicated Advanced Product Support line at **844-Kichler (844-542-4537)** or email techsupport@Kichler.com.

INTERIOR | EXTERIOR | FANS | LANDSCAPE | LIGHTING SYSTEMS

Symbols & Abbreviations



Damp Location: An exterior or interior location that is normally or periodically subject to condensation of moisture in, on, or adjacent to, electrical equipment, and includes partially protected locations.



Federal Communications Commission devices designated with this logo comply with part 15 of the FCC Rules.



2016 Title 24, Part 6 is a document that contains the California Building Energy Efficiency Standards for Residential and Nonresidential Buildings as regulated by the California Energy Commission. Products marked with this logo and labeled as JA8-2016 or JA8-2016-E have been found to meet the requirements stated in 2016 Title 24, Part 6. For more information, visit www.energy.ca.gov/title24.



All electrical products are UL/CSA/ or ETL Listed and Certified to UL/CSA Standards for use in U.S.A. and Canada except where noted.



Kichler Lighting is a member of the American Lighting Association (ALA), a trade association representing the residential lighting and ceiling fan industries in the United States and Canada. Its membership includes leading lighting and fan manufacturers, showrooms (retailers), manufacturers representatives and designers. ALA members are dedicated to providing the public with the proper application of quality residential lighting.

To serve you better, Kichler reserves the right to make improvements to products in this catalog. Therefore, some products may change during the life of the catalog and the product information contained in this catalog may also have changed.

CONNECT WITH US



Follow us: [instagram.com/KichlerLighting](https://www.instagram.com/KichlerLighting)
 Like us: [facebook.com/Kichler.Lighting](https://www.facebook.com/Kichler.Lighting)
 Follow us: twitter.com/KichlerLight
 Join us: [houzz.com/pro/KichlerLighting/Kichler](https://www.houzz.com/pro/KichlerLighting/Kichler)
 Find us: [pinterest.com/KichlerStyle](https://www.pinterest.com/KichlerStyle)
 Watch us: [youtube.com/KichlerLighting](https://www.youtube.com/KichlerLighting)

KICHLER LIGHTING
 7711 East Pleasant Valley Road
 PO Box 318010
 Cleveland, Ohio 44131-8010

To find an Authorized Dealer, visit Kichler.com/where-to-buy

Abbreviation Key

A.....	Amps
ADA.....	Americans with Disabilities Act
AL.....	Aluminum
ALM.....	Light Almond
AWG.....	American Wire Gauge system
AZ.....	Architectural Bronze™
BK.....	Black
BKT.....	Textured Black
BW.....	Brown
BX.....	Armored Cable
BZT.....	Textured Bronze
CH.....	Chrome
CLR.....	Clear
CRI.....	Color Rendering Index
D.....	Depth
DC.....	Direct Current
ELV.....	Electronic Low Voltage
FST.....	Frosted
G.....	Gauge
H.....	Height
IC.....	Insulation Contact
K.....	Kelvin Temperature
KO.....	Knock Out
L.....	Length
LED.....	Light Emitting Diode
MAX.....	Maximum
NI.....	Brushed Nickel
NIT.....	Textured Nickel
NM.....	Nonmetallic Sheathed Cable
NRTL.....	Nationally Recognized Testing Laboratory
RGB.....	Red, Green, Blue Light
SELV.....	Safety Extra Low Voltage
SI.....	Silver Various
SIL.....	Silver
V.....	Volt
W.....	Watt, when directly next to a number
W.....	Width, when paired with L and/or H
WH.....	White
WHO.....	White Opaque
WHT.....	Textured White

Index

Under Cabinet Lighting

10041 WH.....	8	10084 FST.....	9	4U27K08 BZT, WHT.....	7	4U30K30 BZT, WHT.....	7
10042 WH.....	8	10570 BK, WH.....	9	4U27K12 BZT, WHT.....	7	6UCORD BK, WH.....	9
10043 WH.....	8	10571 BK, WH.....	9	4U27K22 BZT, WHT.....	7	6UCSK08 BZT, NIT, WHT.....	6
10044 WH.....	8	10572 BK, WH.....	9	4U27K30 BZT, WHT.....	7	6UCSK12 BZT, NIT, WHT.....	6
10081 FST.....	9	10573 BK, WH.....	9	4U30K08 BZT, WHT.....	7	6UCSK22 BZT, NIT, WHT.....	6
10082 FST.....	9	10588 SI.....	9	4U30K12 BZT, WHT.....	7	6UCSK30 BZT, NIT, WHT.....	6
10083 FST.....	9	10589 SI.....	9	4U30K22 BZT, WHT.....	7		

Tape & Accent Lighting

10181.....	16	4DD12V060 WH.....	22, 23	6T110S27 BK, WH.....	17	8T1001H27 WH.....	15
10183.....	16	4T116H27 WH.....	19	6T110S30 BK, WH.....	17	8T1001H30 WH.....	15
10189 BK, WH.....	25	4T116H30 WH.....	19	6T110UH27 BK, WH.....	17	8T1001H40 WH.....	15
10190BK30.....	23	4T116H50 WH.....	19	6T110UH30 BK, WH.....	17	8T1001H50 WH.....	15
10190BK48.....	23	4T116S27 WH.....	19	6T110UH50 BK, WH.....	17	8T1001S22 WH.....	15
10190BK60.....	23	4T116S30 WH.....	19	6T116S24 BK, WH.....	17	8T1001S27 WH.....	15
10193 BK.....	23	4T116S50 WH.....	19	6T116S27 BK, WH.....	17	8T1001S30 WH.....	15
10198 BK, WH.....	25	4T1100H27 WH.....	19	6T116S30 BK, WH.....	17	8T1001S40 WH.....	15
120RGB BK, WH.....	18	4T1100H30 WH.....	19	6T116S50 BK, WH.....	17	8T1001S50 WH.....	15
1C1 BK, WH.....	26	4T1100H50 WH.....	19	6T120H24 BK, WH.....	17	8T1010H22 WH.....	15
1C1RGB BK, WH.....	26	4T1100S27 WH.....	19	6T120H27 BK, WH.....	17	8T1010H27 WH.....	15
1DC2 BK, WH.....	25	4T1100S30 WH.....	19	6T120H30 BK, WH.....	17	8T1010H30 WH.....	15
1DC3 BK, WH.....	25	4T1100S50 WH.....	19	6T120H50 BK, WH.....	17	8T1010H40 WH.....	15
1DCSWITCH BK, WH.....	25	4TD12V40 BKT.....	23	6T210H24 WH.....	16	8T1010H50 WH.....	15
1DDTRIM ALM.....	22	4TD12V60 BKT.....	23	6T210S24 WH.....	16	8T1010S22 WH.....	15
1DDTRIM BK.....	22	4TP12V30 BK.....	23	6T216S24 WH.....	16	8T1010S27 WH.....	15
1DDTRIM BW.....	22	4TP12V60 BK.....	23	6T220H24 WH.....	16	8T1010S30 WH.....	15
1DDTRIM WH.....	22	5W14G250 WH.....	27	6T1100H27 BK, WH.....	17	8T1010S40 WH.....	15
1IC02 BK, WH.....	26	5W14G500 WH.....	27	6T1100H30 BK, WH.....	17	8T1010S50 WH.....	15
1IC02RGB BK, WH.....	26	5W16G250 WH.....	27	6T1100H50 BK, WH.....	17	8T1010U22 WH.....	15
1IC06 BK, WH.....	26	5W16G500 WH.....	27	6T1100S27 BK, WH.....	17	8T1010U27 WH.....	15
1IC12 BK, WH.....	26	5W18G250 WH.....	27	6T1100S30 BK, WH.....	17	8T1010U30 WH.....	15
1IC12RGB BK, WH.....	26	5W18G500 WH.....	27	6T1100S50 BK, WH.....	17	8T1010U40 WH.....	15
1IC36 BK, WH.....	26	5W24G250 BK, WH.....	27	6TD24V10 BKT.....	23	8T1010U50 WH.....	15
1IC36RGB BK, WH.....	26	6D24V27 BKT, BZT, NIT, WHT... 20		6TD24V40 BKT.....	23	8T1033H22 WH.....	15
1IC96 BK, WH.....	26	6D24V30 BKT, BZT, NIT, WHT... 20		6TD24V60 BKT.....	23	8T1033H27 WH.....	15
1IC96RGB BK, WH.....	26	6DD24V060 WH.....	22, 23	6TD24V96 BKT.....	23	8T1033H30 WH.....	15
1SL2 BK, WH.....	25	6DD24V100 WH.....	22, 23	8T1TTF1 WH.....	14	8T1033H40 WH.....	15
1SL2RGB BK, WH.....	25	6HS0CLIPS.....	21	8T1TTF2 WH.....	14	8T1033H50 WH.....	15
1SL8 BK, WH.....	25	6HS1IC02 WH.....	21	8T1TTF3 WH.....	14	8T1067S22 WH.....	15
1SL8RGB BK, WH.....	25	6HS1IC06 WH.....	21	8T1TTF4 WH.....	14	8T1067S27 WH.....	15
1SLW2 BK, WH.....	25	6HS1IC12 WH.....	21	8T1TTR1 WH.....	14	8T1067S30 WH.....	15
1SLW8 BK, WH.....	25	6HS1IC36 WH.....	21	8T1TWF1 WH.....	14	8T1067S40 WH.....	15
2C1 WH.....	26	6HS1IC96 WH.....	21	8T1TWR1 WH.....	14	8T1067S50 WH.....	15
2IC02 WH.....	26	6HS1SL8DC WH.....	21	8T1TWRS WH.....	14	8T1100H22 WH.....	15
2IC06 WH.....	26	6HS1SL8 WH.....	21	8T1000H22 WH.....	15	8T1100H27 WH.....	15
2IC12 WH.....	26	6HS27K06 AL.....	21	8T1000H27 WH.....	15	8T1100H30 WH.....	15
2IC36 WH.....	26	6HS27K12 AL.....	21	8T1000H30 WH.....	15	8T1100H40 WH.....	15
2IC96 WH.....	26	6HS30CLIPS.....	21	8T1000H40 WH.....	15	8T1100H50 WH.....	15
2SL2 WH.....	25	6HS30K06 AL.....	21	8T1000H50 WH.....	15	8T1100S22 WH.....	15
2SL8 WH.....	25	6HS30K12 AL.....	21	8T1000S22 WH.....	15	8T1100S27 WH.....	15
2SLW2 WH.....	25	6HS45CLIPS.....	21	8T1000S27 WH.....	15	8T1100S30 WH.....	15
2SLW8 WH.....	20	6HS50K06 AL.....	21	8T1000S30 WH.....	15	8T1100S40 WH.....	15
4D12V27 KT, BZT, NIT, WHT... 20		6HS50K12 AL.....	21	8T1000S40 WH.....	15	8T1100S50 WH.....	15
4D12V30 KT, BZT, NIT, WHT... 20		6T110H27 BK, WH.....	17	8T1000S50 WH.....	15		
4DD12V040 WH.....	22, 23	6T110H30 BK, WH.....	17	8T1001H22 WH.....	15		

Extruded Channels for Tape Light

10170 BK, WH 67	1TEC1DWRC8SIL 62	1TEE1RDSFSSIL 34	1TEK1STSF2SIL 60
10171 BK, WH 67	1TEC1DWSF8SIL 60	1TEE1SKSFSSIL 32	1TEK1STSF4SIL 60
10172 BK, WH 67	1TEC1FLRC8SIL 49	1TEE1STRCSSIL 62	1TEK1STSF8SIL 60
10173 BK, WH 67	1TEC1IC1DW8SIL 38	1TEE1STSFHSIL 60	1TEK1SWRC2SIL 62
10174 BK, WH 67	1TEC1IC2DW8SIL 38	1TEE1STSFSSIL 60	1TEK1SWRC4SIL 62
10175 BK, WH 67	1TEC1RDSF8SIL 34	1TEE1SWRCSSIL 62	1TEK1SWRC8SIL 62
10176 BK, WH 67	1TEC1SKSF8SIL 32	1TEE1SWSFHSIL 60	1TEK1SWSF2SIL 60
10177 BK, WH 67	1TEC1STRC8SIL 62	1TEE2DMRCSSIL 36	1TEK1SWSF4SIL 60
10178 BK, WH 67	1TEC1STSF8SIL 60	1TEE2DWRCCSSIL 56	1TEK1SWSF8SIL 60
10179 67	1TEE1SWSFSSIL 60	1TEE2DWSFSSIL 54	1TEL0018CLR 32, 34, 38 46, 52, 60, 62
12330 BK, WH 67	1TEC1SWRC8SIL 62	1TEE2M1SFSIL 40	1TEL0018WHO 32, 34, 38 46, 52, 60, 62
1TE1SWSFSSIL 60	1TEC1SWSF8SIL 60	1TEE2M2SFSSIL 40	1TEL0028WHO 36, 40, 42 44, 54, 56
1TEA090HCONN 34, 36, 40 42, 44, 46, 54, 56, 66	1TEC2DMRC8SIL 36	1TEE2S1SFSSIL 44	1TEL0038WHO 52, 54, 56
1TEA090VCONN 34, 36, 40 42, 44, 46, 54, 56, 66	1TEC2DWSF8SIL 54	1TEE2STRCSSIL 56	1TEL0068WHO 36
1TEA120HCONN 34, 36, 40 42, 44, 46, 54, 56, 66	1TEC2M1SF8SIL 40	1TEE2STSFSSIL 54	1TEL1518CLR 32, 34, 38 52, 60, 62
1TEA180HCONN 34, 36, 40 42, 44, 46, 54, 56, 66	1TEC2M2SF8SIL 40	1TEE2W1RCSSIL 42	1TEL3018CLR 32, 34, 38 52, 60, 62
1TEA1DWADJ8SIL 60, 65	1TEC2S1SF8SIL 44	1TEE2W2RCSSIL 42	1TELC008WHO 46
1TEA1RDADJ8SIL 34, 66	1TEC2SMRC8SIL 36	1TEE3DWRCCSSIL 56	1TELF18WHO 48, 49
1TEA1RDSFBAESIL 34, 66	1TEC2STRC8SIL 56	1TEE3DWSFSSIL 54	1TELH018WHO 60
1TEA1RDSFBCCH 34, 66	1TEC2STSF8SIL 54	1TEE3SWSFSSIL 52	1TEM130SFCLR 52
1TEA1RDSFHCCCH 34, 66	1TEC2W1RC8SIL 42	1TEE4S2SFSSIL 44	1TEM145SFCLR 60
1TEA1RDSFHCOCH 34, 66	1TEC2W2RC8SIL 42	1TEE4TRSFSSIL 48	1TEM1DWSFCLR 60
1TEA1RDSFLCCCH 34, 66	1TEC3DWRCCSSIL 56	1TEE4W3RCSSIL 42	1TEM1RDSFSCCH 34
1TEA1RDSFLCOCH 34, 66	1TEC3DWSF8SIL 54	1TEE6EMRCSSIL 36	1TEM1STFMCLR 60
1TEA4TRSF8BK 48, 66	1TEC3SWSF8SIL 52	1TEK145SF2SIL 60	1TEM1SWSFMCLR 60
1TEASPKSUSSIL 44, 52, 54 60, 66	1TEC4S2SF8SIL 44	1TEK145SF4SIL 60	1TEMME1SF8SIL 40
1TEC130SF8SIL 52	1TEC4TRSF8SIL 48	1TEK1DWRC2SIL 62	1TEMME2SF8SIL 44
1TEC145SF8SIL 60	1TEC4W3RC8SIL 42	1TEK1DWRC4SIL 62	1TEMSC1RC 36, 42, 46, 56, 66
1TEC1C1RC8SIL 46	1TEC6EMRC8SIL 36	1TEK1DWRC8SIL 62	
1TEC1C2RC8SIL 46	1TEE130SFSSIL 52	1TEK1DWSF2SIL 60	
1TEC1DC1DW8SIL 38	1TEE145SFSSIL 60	1TEK1DWSF4SIL 60	
1TEC1DC2DW8SIL 38	1TEE1C1RCSSIL 46	1TEK1DWSF8SIL 60	
	1TEE1C2RCSSIL 46	1TEK1STRC2SIL 62	
	1TEE1DWRCCSSIL 62	1TEK1STRC4SIL 62	
	1TEE1DWSFSSIL 60	1TEK1STRC8SIL 62	
	1TEE1FLRCSSIL 49		

Step & Hall Lighting

12600 AZ, WH 70	12663 ALM, AZ, NI, WH 70	12668 ALM, AZ, NI, WH 71	12676 ALM, AZ, NI, WH 71
12602 AZ, WH 70	12664 ALM, AZ, NI, WH 70	12672 ALM, AZ, NI, WH 70	12677 ALM, AZ, NI, WH 71
12604 AZ, WH 71	12665 ALM, AZ, NI, WH 70	12673 ALM, AZ, NI, WH 70	12678 ALM, AZ, NI, WH 71
12606 AZ, WH 71	12666 ALM, AZ, NI, WH 71	12674 ALM, AZ, NI, WH 70	
12662 ALM, AZ, NI, WH 70	12667 ALM, AZ, NI, WH 71	12675 ALM, AZ, NI, WH 70	

Understanding Color Temperature

The color of your light sets the tone

Did you know that not all white light is created equal? Many of our LED fixtures come in a variety of color temperatures – known as Kelvin (K) temperature – that can enhance the colors in your space.



2200K/2400K - Amber White



2700K - Warm White



3000K - Pure White



4000K - Cool White



5000K - Bright White



Our Vision

At Kichler Lighting, everything we do, every single day, is with the intention of creating and delivering products that allow people to see what matters most to them. We will do that by relentlessly pursuing quality, ensuring continued innovation, always going one step further in our commitment to exceptional customer service and education, as well as creating on-trend designs that are both stylish and “life-stylish,” promising to deliver project success for you.

Get inspired at [Kichler.com](https://www.kichler.com)

Featured on Front / Back Cover: Tape Lighting 8T Series 24V LED, Page 14 • TE Pro Series Channels | Sleek, Page 32
Transitional Crown, Page 40 | Ceiling Edge Arch, Page 42 | Broad/Transitional Corridor, Page 46

Catalog No. K519 | www.kichler.com | Printed in USA. LS18006-40M | For more information call: 866.558.5706

2019 © Kichler Lighting LLC. All Rights Reserved. The majority of newer Kichler fixtures are U.S. Patent Pending.